

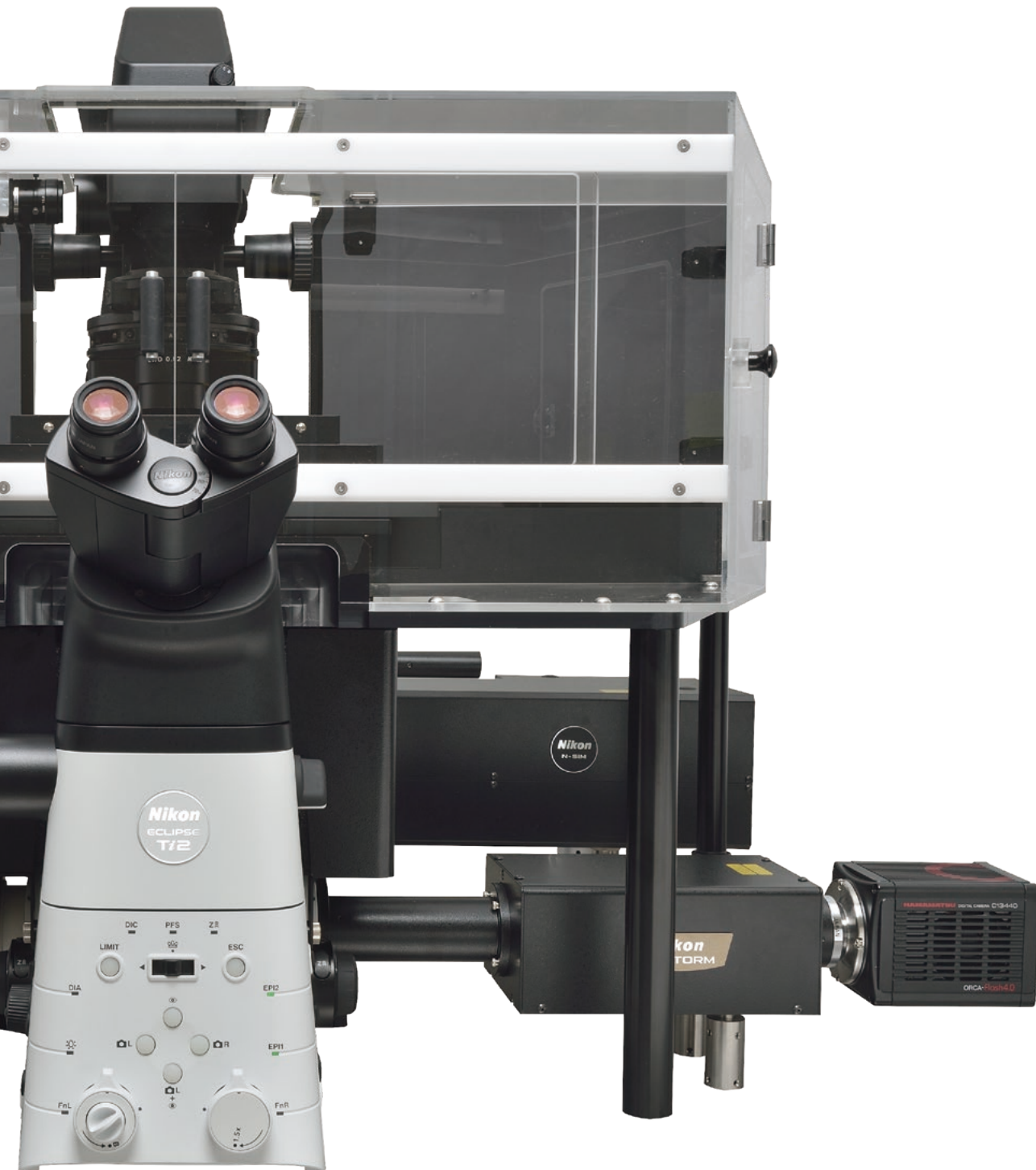

Super Resolution Microscopes

Shedding New Light On **MICROSCOPY**

Super Resolution Microscopes



A brand new era in super resolution

The N-SIM S Super Resolution Microscope utilizes a unique high-speed structured illumination system to achieve acquisition speeds of up to 15 fps*, enabling fast biological processes to be captured at twice the spatial resolution of conventional light microscopes (~115nm** in XY).

The N-STORM Super Resolution Microscope achieves a 10-fold improvement in resolution compared to conventional light microscopes (~20 nm in XY), enabling observation at the true molecular level.

The N-SIM S and N-STORM can be easily combined within the same imaging system for greater flexibility in nanoscale imaging experiments. They can be further combined with confocal microscope system such as the AX to create a single versatile platform for multi-scale imaging. Powered at the core by the industry-leading Ti2 inverted microscope with its ultra-flexible design, nano-precision Z-drive and Perfect Focus System, the possibilities for experimental design are limitless.

* TIRF-SIM/2D-SIM mode, 512 x 512 pixels, 2 msec exposure time

** FWHM of 100 nm bead images collected in 3D-SIM mode, using 488 nm excitation laser. In TIRF-SIM mode, 86 nm is achieved using 40 nm beads excited by a 488 nm laser.



N-SIM S

Structured illumination microscopy

15 fps image acquisition

Lateral resolution of ~115 nm

Axial resolution of ~269 nm



N-STORM

Stochastic optical reconstruction microscopy

Lateral resolution of ~20 nm

Axial resolution of ~50 nm

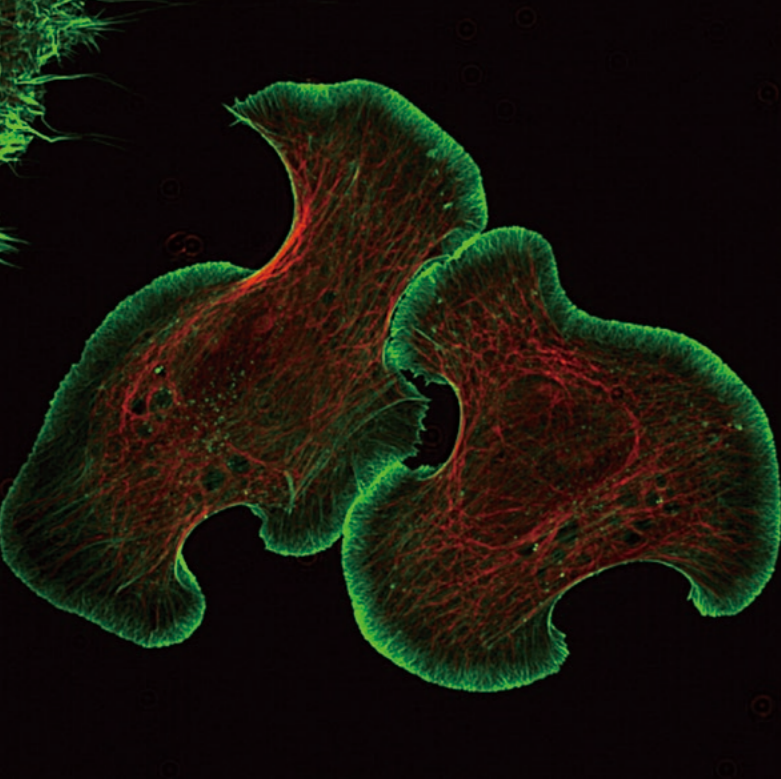

Lamellipodia of NG108 cell labeled with Alexa Fluor® 488 for actin (green) and TRITC-Phalloidin for microtubules (red). Photo courtesy of: Drs. Shizuha Ishiyama and Kaoru Katoh, The National Institute of Advanced Industrial Science and Technology (AIST)

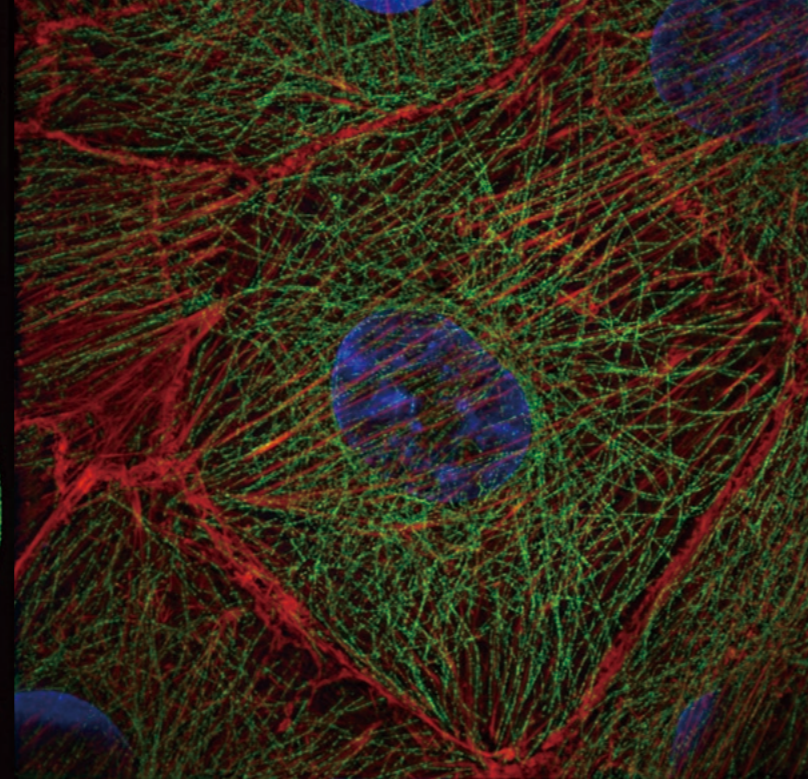

LLC-PK1 cell labeled with DAPI for nucleus (blue), Alexa Fluor® 488 for microtubules (green) and TRITC-Phalloidin for actin (red). Photo courtesy of: Dr. Kaoru Katoh, The National Institute of Advanced Industrial Science and Technology (AIST)

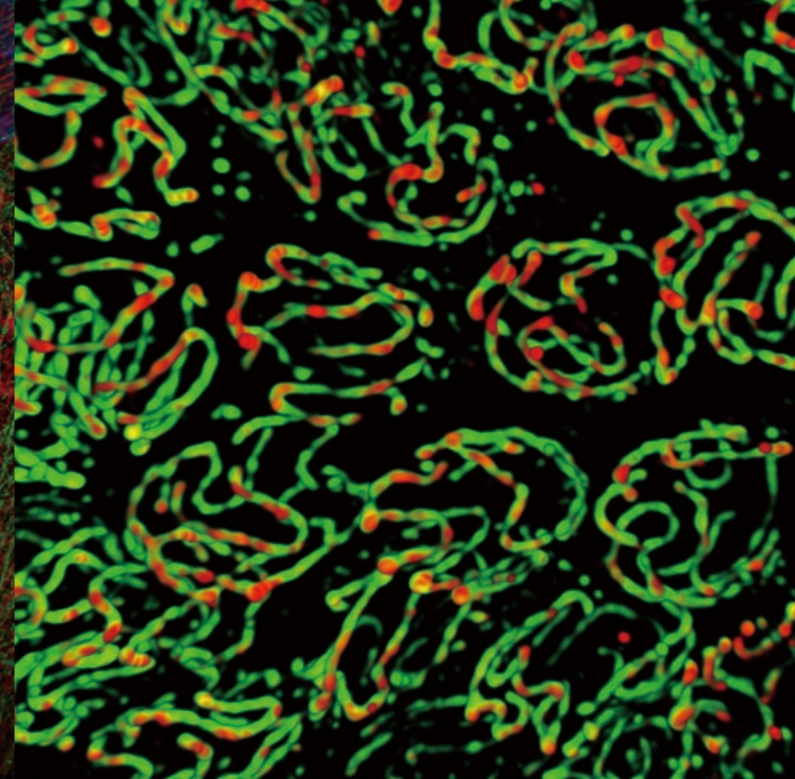

Synaptonemal complexes of *C. elegans* pachytene germ cells labeled with anti-SYP-1 antibodies. Photo courtesy of: Tyler Machovina and Dr. Judith Yanowitz, Magee-Womens Research Institute.

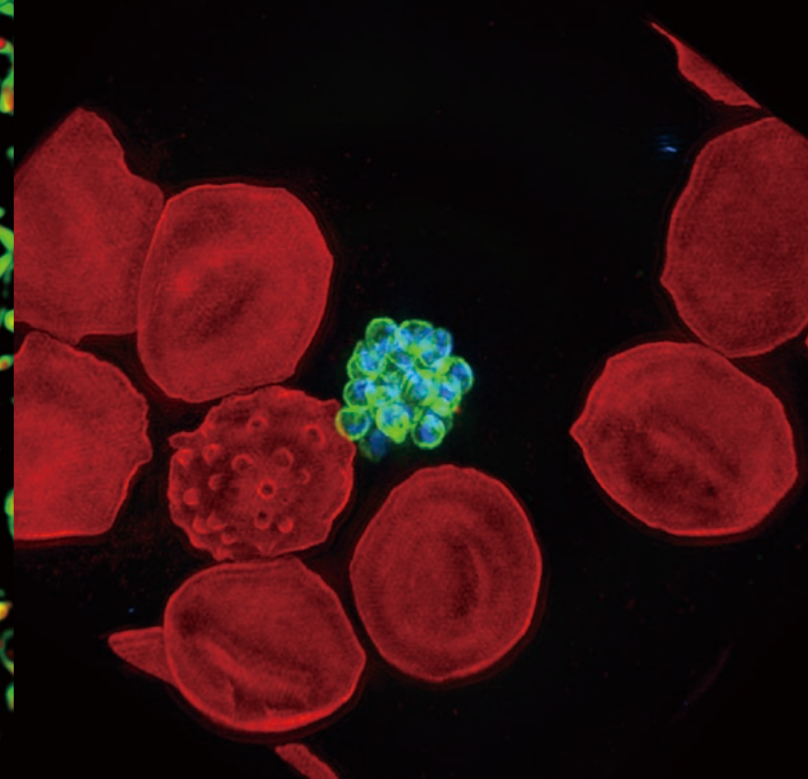

Malaria parasite surface (MTIP) labeled with Alexa Fluor® 488 (green), Erythrocyte membrane (Band 3) labeled with Alexa Fluor® 568 (red), DNA labeled with DAPI (blue). *Scientific Reports* DOI:10.1038/s41598-018-22026-0 Photo courtesy of: Drs. Masayuki Morita, Eizo Takashima, Tadahiromimura, Takafumi Tsuboi, Proteo-Science Center, Ehime University

N-SIMS

See life in super resolution

The N-SIMS combines innovative structured illumination microscopy technology with unparalleled optics to double the resolution of conventional light microscopes. With acquisition speeds of up to 15 fps, the N-SIMS enables high-speed super resolution imaging of dynamic events in live cells.

- ❖ Captures rapid changes in live cells at 15 fps*
- ❖ Twice the resolution of conventional light microscopes (approx. 115 nm**), utilizing structured illumination microscopy
- ❖ Automatic switching between different illumination modes
- ❖ Two-channel TIRF-SIM acquisition
- ❖ Acquires larger fields of view (66 μm x 66 μm***)
- ❖ Compatible with easy-to-use dry objectives
- ❖ Simultaneous two-channel imaging (optional)

* TIRF-SIM/2D-SIM mode, 512 x 512 pixels, 2 msec exposure time

** FWHM of 100 nm bead images collected in 3D-SIM mode, using 488 nm excitation laser. In TIRF-SIM mode, 86 nm is achieved using 40 nm beads excited by a 488 nm laser.

*** Field of view using a 100X objective.



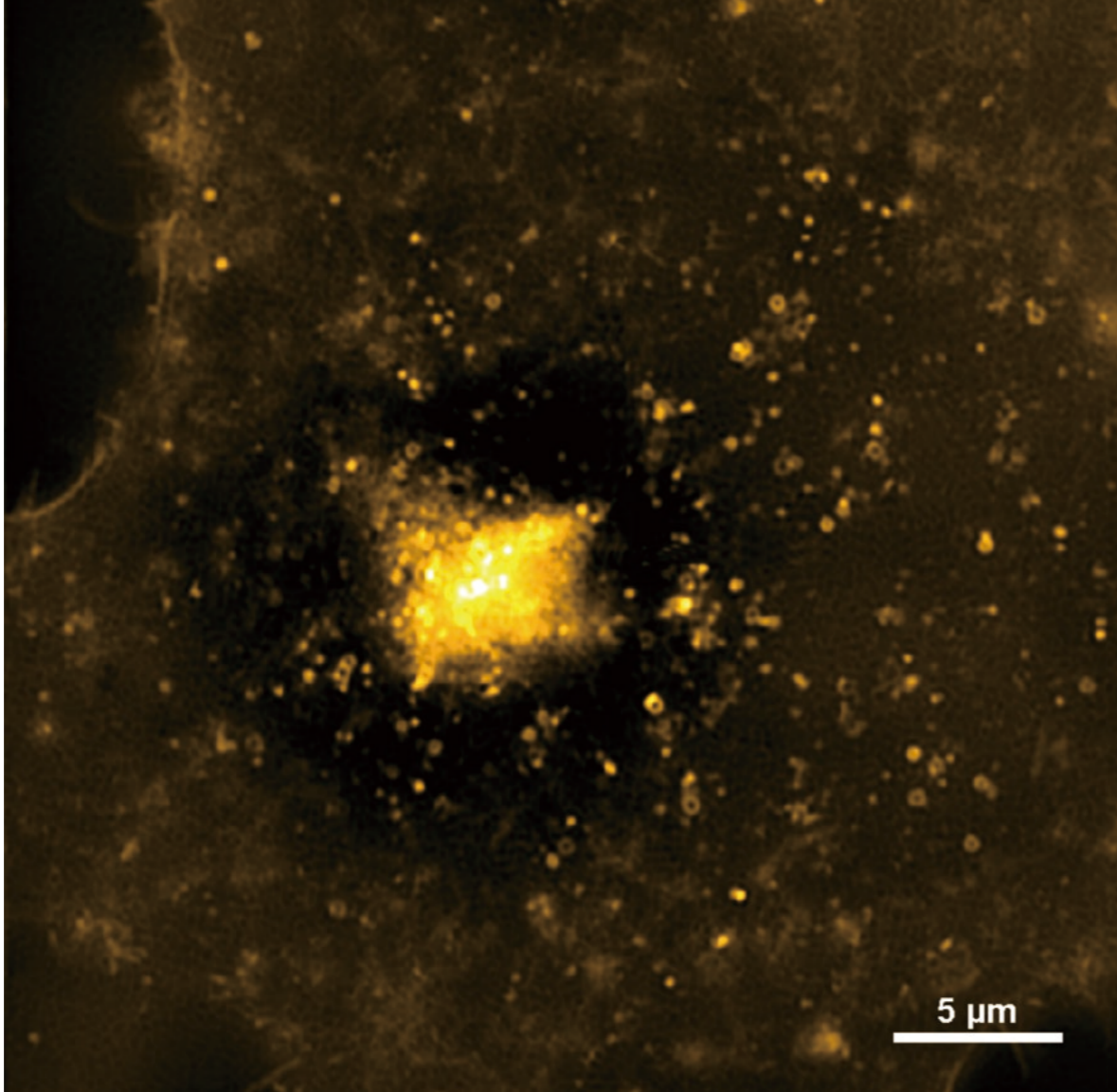

Endosomes of COS7 cell labeled with YFP. Rapid movement of endosomes is captured at high resolution.
 Image acquisition speed: 6 fps
 Imaging mode: 3D-SIM
 Image courtesy of: Yasushi Okada, M.D., Ph.D., Department of Physics, Graduate School of Science, The University of Tokyo

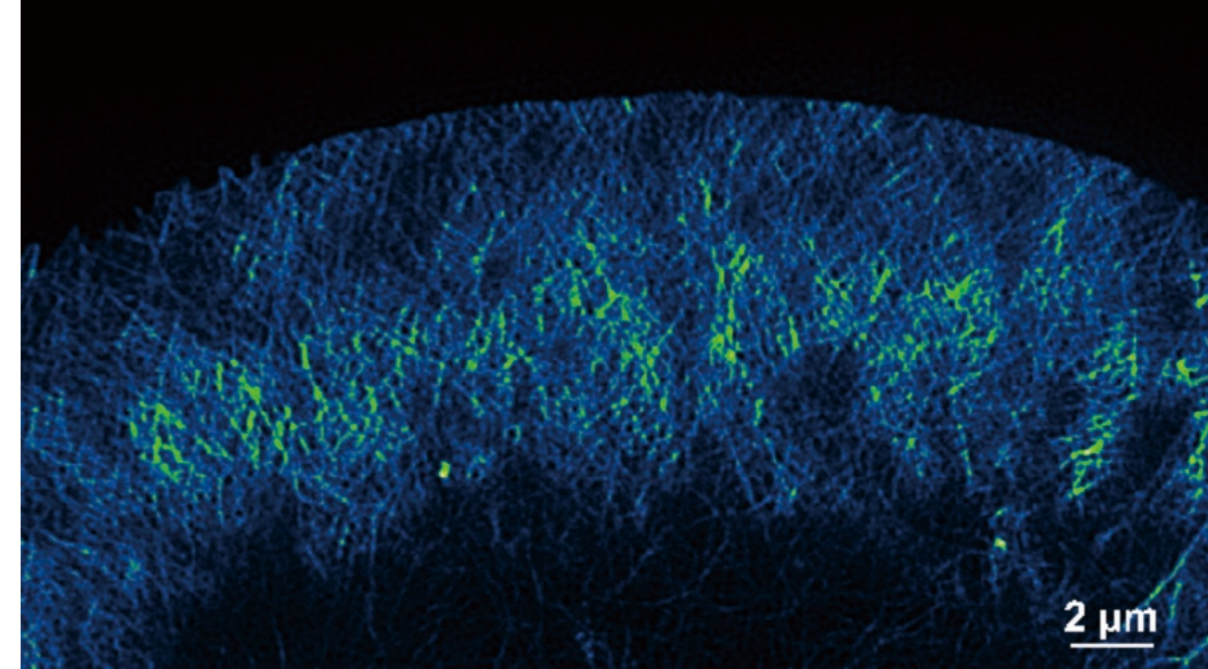

Growth cone of NG108 cell labeled with GFP-Lifeact for F-actin. Formation of actin mesh is captured at high-speed.
 Image acquisition speed: 10 fps
 Imaging mode: TIRF-SIM
 Image courtesy of: Drs. Minami Tanaka and Kaoru Katoh, The National Institute of Advanced Industrial Science and Technology (AIST)

Histone H2B-GFP expressing in a HeLa cell. Visualization of fine movements of chromatin domains in different locations.
 Image acquisition speed: 3.9 fps
 Imaging mode: 3D-SIM
 Image courtesy of: Yuko Sato, Ph.D. and Hiroshi Kimura, Ph.D., Cell Biology Center, Institute of Innovative Research, Tokyo Institute of Technology

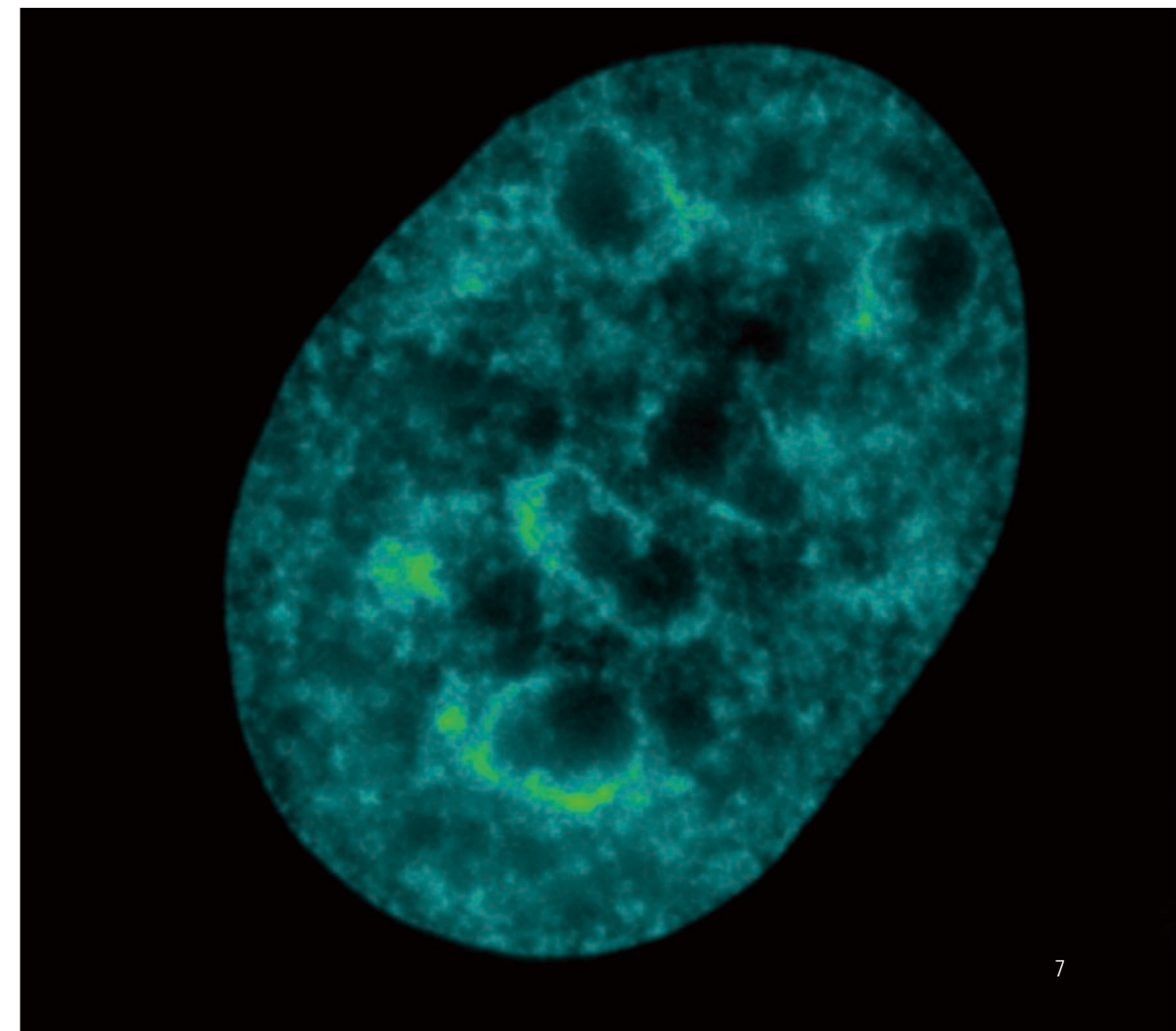

Capture rapid changes in live cells

High-speed super-resolution imaging at 15 fps

Nikon's new high-speed structured illumination system utilizes a novel pattern modulation technology to generate fast and precise switching of illumination patterns. The N-SIM S Super Resolution Microscope achieves incredible acquisition speeds (up to 15 fps*), enabling super-resolution time-lapse imaging of live cells and intracellular dynamics. Discover a new level of live-cell imaging with the N-SIM S.

* TIRF-SIM/2D-SIM mode, 512 x 512 pixels, 2 msec exposure time



N-SIM S
product page

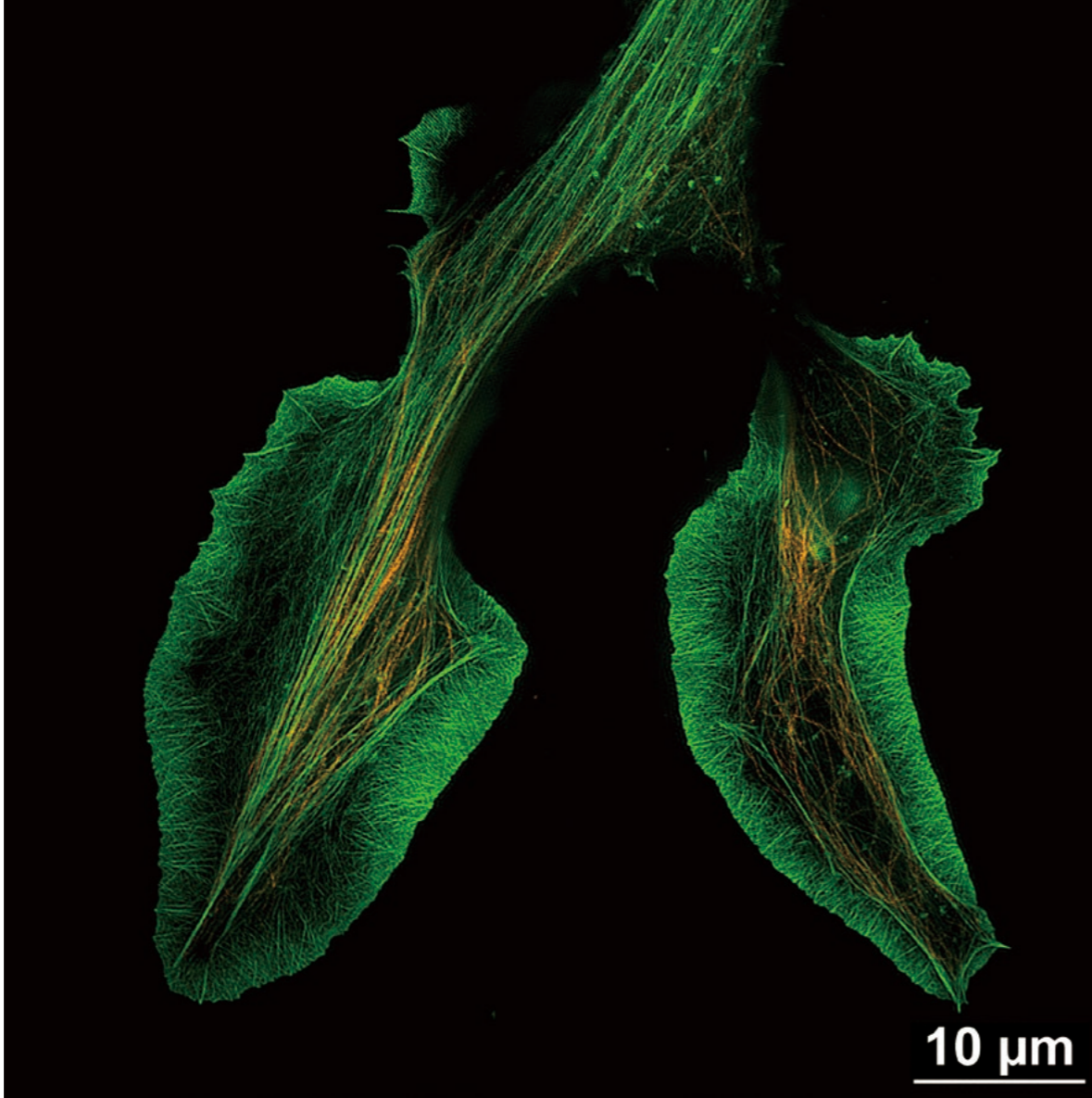

Two-color TIRF-SIM imaging of growth cone of NG108 cell labeled with Alexa Fluor® 488 for F-actin (green) and Alexa Fluor® 555 for microtubules (orange)
 Reconstructed image size: 2048 x 2048 pixels (66 µm x 66 µm with a 100X objective)
 Sample courtesy of: Drs. Shizuha Ishiyama and Kaoru Katoh, The National Institute of Advanced Industrial Science and Technology (AIST)

Easily switch between imaging modes for optimal results

Automatic switching between illumination modes

Newly-developed, high-speed structured illumination technology not only enables fast acquisition rates but also automatic switching between illumination modes and automated optimization of structured illumination patterns for different wavelengths and magnifications. This expanded automation enables fast 2-color TIRF-SIM imaging as well as multiplexing of different SIM modalities. The N-SIM S provides easy-to-use, streamlined workflows, whether it be for single-mode or multi-modal imaging experiments.

Acquire larger fields of view

The N-SIM S can acquire super-resolution images with a large field of view of 66 µm square. This larger imaging area enables very high throughput for applications/samples that benefit from larger fields of view, such as a neurons, reducing the amount of time and effort required to obtain data.

Simultaneous two-channel imaging

Simultaneous two-color imaging is possible by utilizing an optional Two Camera Imaging Adaptor* and two sCMOS cameras.

*Hamamatsu Photonics K.K.

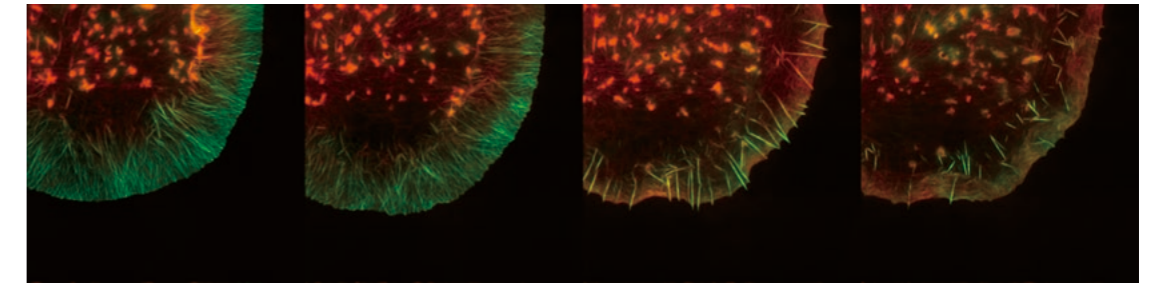

Immediately before drug application 10 minutes after 20 minutes after 30 minutes after
 Growth cone of NG108 cells. Fascin (green): GFP-Fascin, Actin (red): LifeAct-KO Objective Lens : CFI SR HP Apochromat TIRF 100x C Oil
 Using image splitting optical system, dual color time-lapse images were captured after application of drug solution. The time course was recorded that fascin was dissociated from the actin bundles and filamentous actin changed their pattern. Co-localization of fascin and actin and dissociation of fascin were well demonstrated. Optic aberrations and image distortion were adjusted to be less than 30 nm.
 Images courtesy of: Dr. Minami Tanaka, Dr. Kaoru Katoh, Biomedical Research Institute Molecular Neurobiology Group, National Institute of Advanced Industrial Science and Technology

2D-SIM mode/TIRF-SIM mode

This mode captures super-resolution 2D images at high speed with incredible contrast. The TIRF-SIM mode enables Total Internal Reflection Fluorescence observation at double the resolution of conventional TIRF microscopes, facilitating a greater understanding of molecular interactions at the cell surface.

3D-SIM mode

The 3D-SIM mode generates structured illumination patterns in three dimensions to deliver a two-fold improvement in lateral and axial resolution. Two reconstruction methods ("slice" and "stack") are available to optimize results for application requirements (e.g. sample thickness, speed, etc.).

3D-SIM image

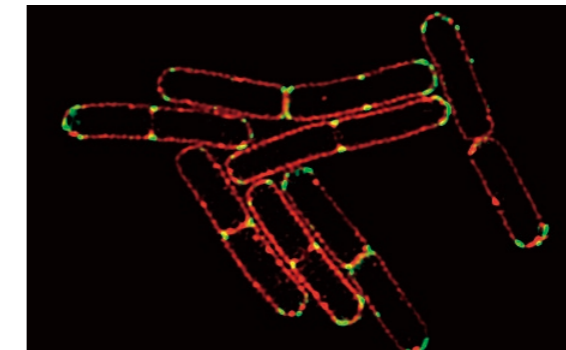

Conventional widefield image

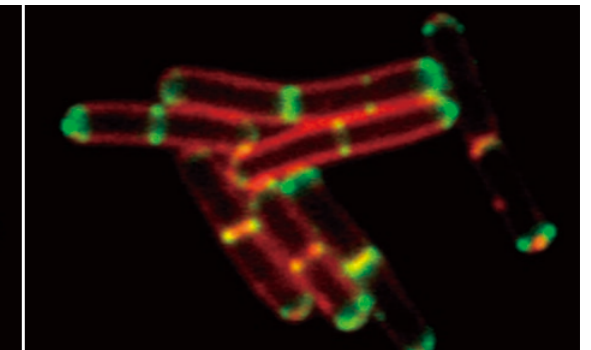

Bacillus subtilis bacterium stained with membrane dye Nile Red (red), and expressing the cell division protein DivIVA fused to GFP (green). The super-resolution microscope enables accurate localization of the protein during division.
 Reconstruction method: Slice
 Photos courtesy of: Drs. Henrik Strahl and Leendert Hamoen, Centre for Bacterial Cell Biology, Newcastle University

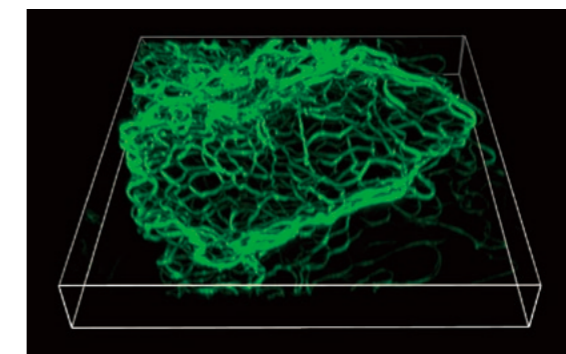

Width: 26.19 µm, Height: 27.11 µm, Depth: 3.36 µm

Mouse keratinocyte indirectly immunolabeled for keratin intermediate filaments and visualized with Alexa Fluor® 488 conjugated secondary antibodies.
 Reconstruction method: Stack
 Photo courtesy of: Dr. Reinhard Windoffer, RWTH Aachen University

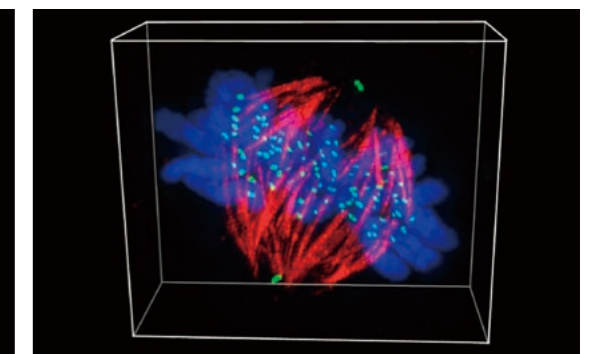

Width: 16.00 µm, Height: 13.36 µm, Depth: 6.00 µm

Human U2OS cell in mitosis metaphase
 The cell is labeled green (kinetochore protein CENP-B), red (alpha-tubulin) and blue (DNA).
 Reconstruction method: Stack
 Photo courtesy of: Dr. Alexey Khodjakov, Wadsworth Center, Albany NY

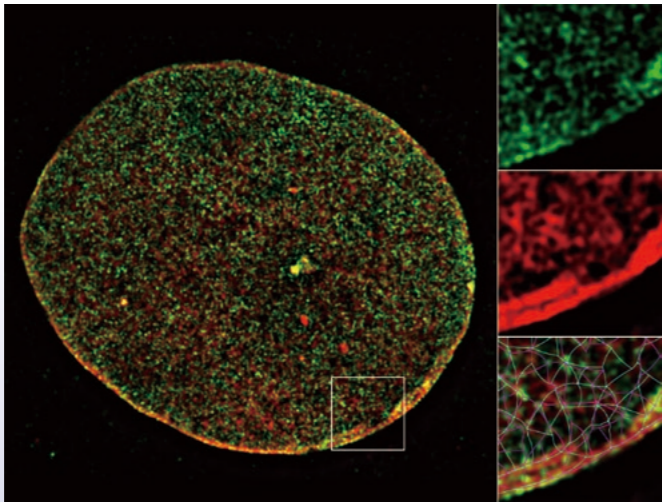

Lamin B1 (red) and Lamin C (green) form separate but interacting meshworks within the lamina of the embryonic fibroblast nucleus of a mouse. Prepared for double indirect immunofluorescence and imaged by 3D-SIM. The meshwork structure was computationally derived from LB1 (cyan) and LC (magenta) 3D-SIM fluorescence data using steerable filters.*1 Photos courtesy of Drs. Takeshi Shimi and Mark Kittisopikul

"N-SIM provides the resolution necessary to identify and evaluate the structural organization of the nuclear lamina*1, *2. Its ease of use and stable performance has made N-SIM an integral research tool in my laboratory."



Dr. Robert D. Goldman
Ellison Foundation Senior Scholar, Stephen Walter Ranson Professor, Chair, Dept. of Cell & Mol. Biol., Feinberg School of Medicine, Northwestern University

*1 *Mol Biol Cell*. 2015 Nov 5; 26(22):4075-86.
*2 *Nature*. 2017 Mar 9; 543(7644):261-264.

N-SIM S system diagram

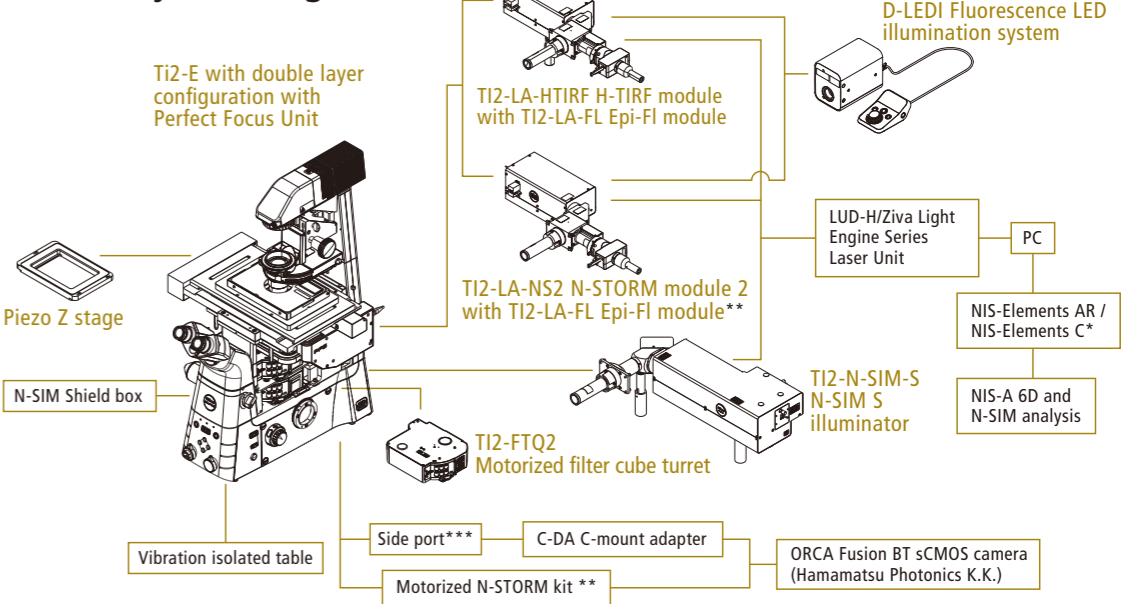

* Required when used with confocal system
** Required when configured with N-STORM
*** Supplied with microscope main body

The principle of Structured Illumination Microscopy

Analytical processing of recorded moiré patterns, produced by overlaying a known high spatial frequency pattern, mathematically restores the sub-resolution structure of a specimen.

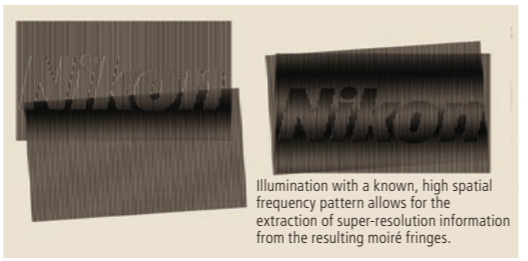

Utilization of high spatial frequency laser interference to illuminate sub-resolution structures within a specimen produces moiré fringes, which are captured. These moiré fringes include modulated information of the sub-resolution structure of the specimen. Through image processing, the unknown specimen information can be recovered to achieve resolution beyond the limit of conventional light microscopes.

Create super-resolution images by processing multiple moiré pattern images

An image of moiré patterns captured in this process includes information of the minute structures within a specimen. Multiple phases and orientations of structured illumination are captured, and the displaced "super-resolution" information is extracted from moiré fringe information. This information is combined mathematically in "Fourier" or aperture space and then transformed back into image space, creating an image at double the conventional resolution limit.

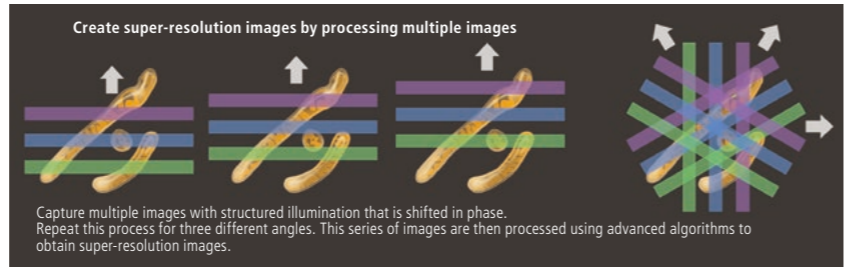

Utilizing high-frequency striped illumination to double the resolution

The capture of high resolution, high spatial frequency information is limited by the Numerical Aperture (NA) of the objectives, and spatial frequencies of structure beyond the optical system aperture are excluded (Fig. A). Illuminating the specimen with high frequency structured illumination, which is multiplied by the unknown structure in the specimen beyond the classical resolution limit, brings the displaced "super-resolution" information within the optical system aperture (Fig. B).

When this "super-resolution" information is then mathematically combined with the standard information captured by the objective lens, it results in resolutions equivalent to those captured with objective lenses with approximately double the NA (Fig. C).

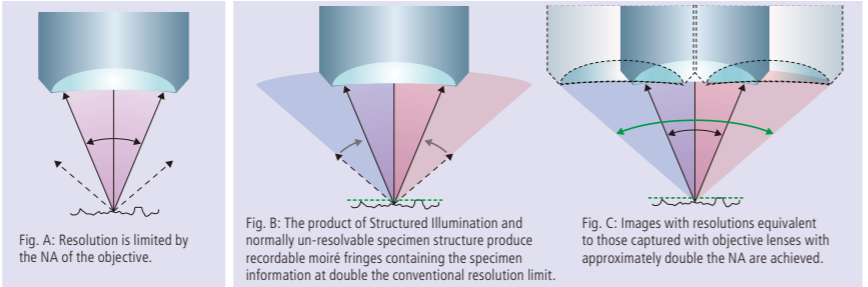

N-SIM S Specifications

Lateral resolution (FWHM of beads in xy)	115 nm ^{*1} in 3D-SIM mode, 86 nm ^{*2} in TIRF-SIM mode	
Axial resolution (FWHM of beads in z)	269 nm ^{*1} in 3D-SIM mode	
Image acquisition time	Up to 15 fps (TIRF-SIM/2D-SIM, 2 msec exposure time)	
Reconstructed image size	1024 x 1024 pixels, 2048 x 2048 pixels	
Imaging mode	TIRF-SIM 2D-SIM 3D-SIM (Reconstruction method: slice, stack)	
Multi-color imaging	Up to 6 colors	
Simultaneous multi-color imaging	Two colors	
Compatible Laser	LUD-H series laser unit (TIRF-SIM) Standard: 405 nm, 488 nm, 561 nm, 640 nm Option: 445 nm, 515 nm	Ziva Light Engine series laser unit (2D/3D-SIM) 405 nm, 446 nm, 476 nm, 518 nm, 545 nm, 637 nm
Compatible microscope	Motorized inverted microscope ECLIPSE Ti2-E Perfect Focus System Motorized XY stage with encoders Piezo Z stage	
Objective	CFI SR HP Plan Apochromat Lambda S 100XC Sil (NA1.35) CFI SR HP Apochromat TIRF 100XC Oil (NA 1.49) CFI SR HP Apochromat TIRF 100XC Oil (NA 1.49) CFI SR Plan Apochromat IR 60XC WI (NA 1.27) CFI SR Plan Apochromat IR 60XC WI (NA 1.27) CFI Plan Apochromat Lambda 60XC (NA 0.95)* ³ CFI Plan Apochromat Lambda D 40XC (NA 0.95)* ³	
Camera	ORCA Fusion BT sCMOS camera (Hamamatsu Photonics K.K.)	
Software	NIS-Elements AR/NIS-Elements C (for Confocal Microscope AX/AX R) Both require additional software modules NIS-A 6D and N-SIM Analysis	
Operating conditions	20 °C to 28 °C (± 1.5 °C)	

*1 These values are measured using 100 nm diameter beads excited by a 488 nm laser. Actual resolution is dependent on laser wavelength and optical configuration.
*2 This value is measured using 40 nm diameter beads excited by a 488 nm laser. Actual resolution is dependent on laser wavelength and optical configuration.
*3 Supports 2D-SIM and 3D-SIM (slice reconstruction).

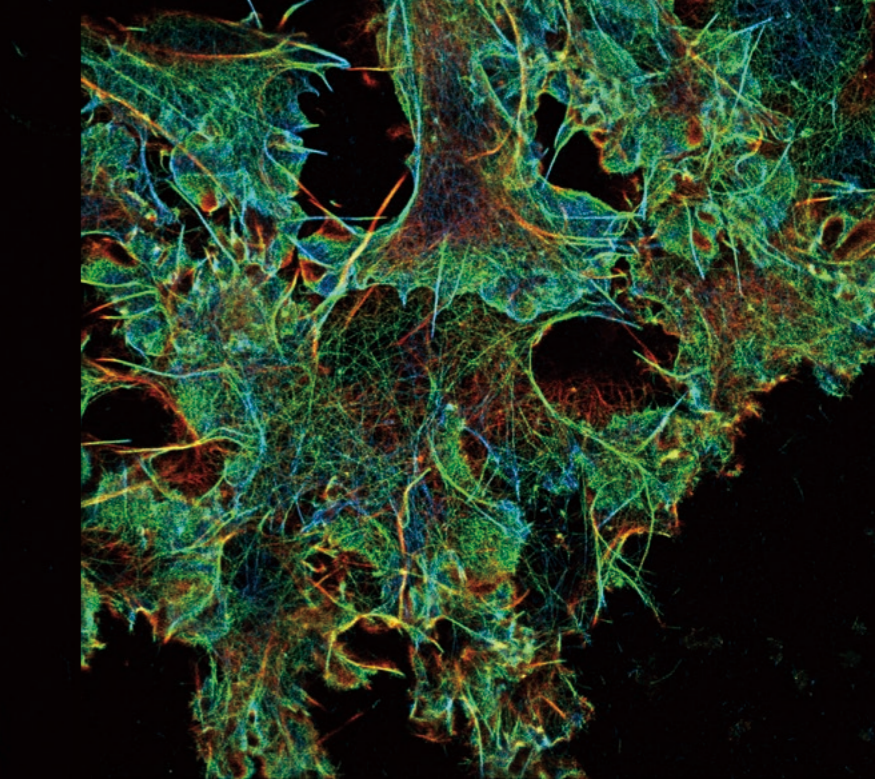
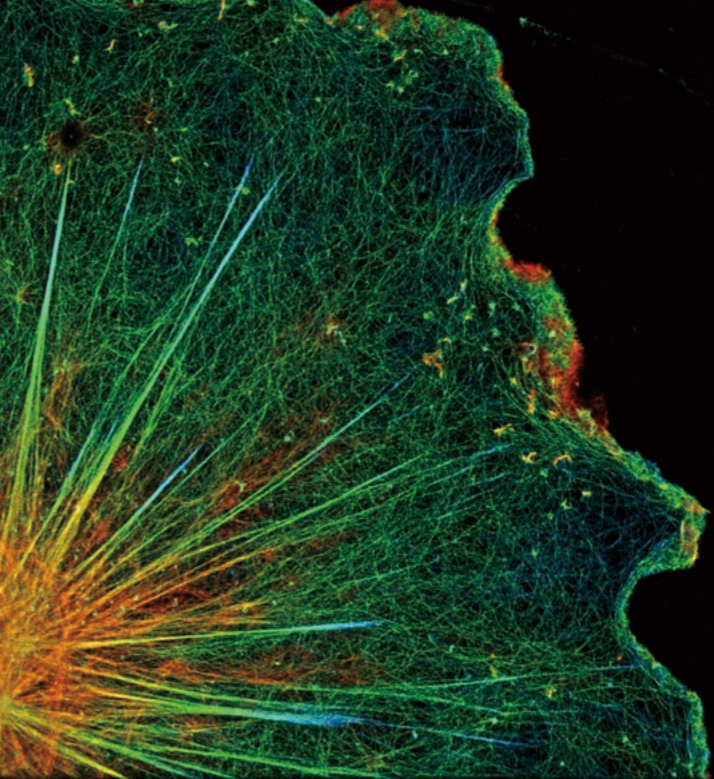
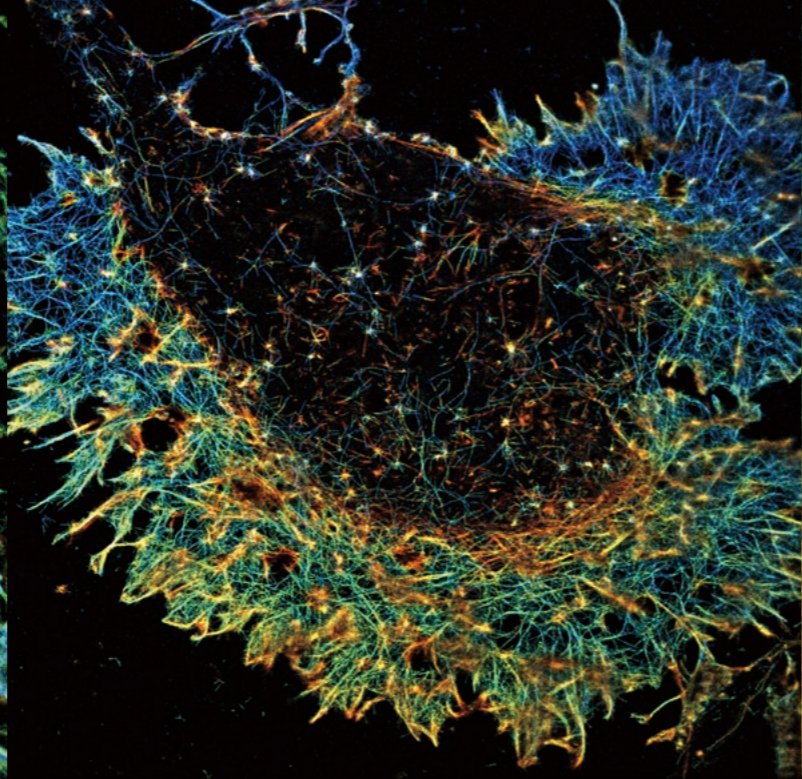
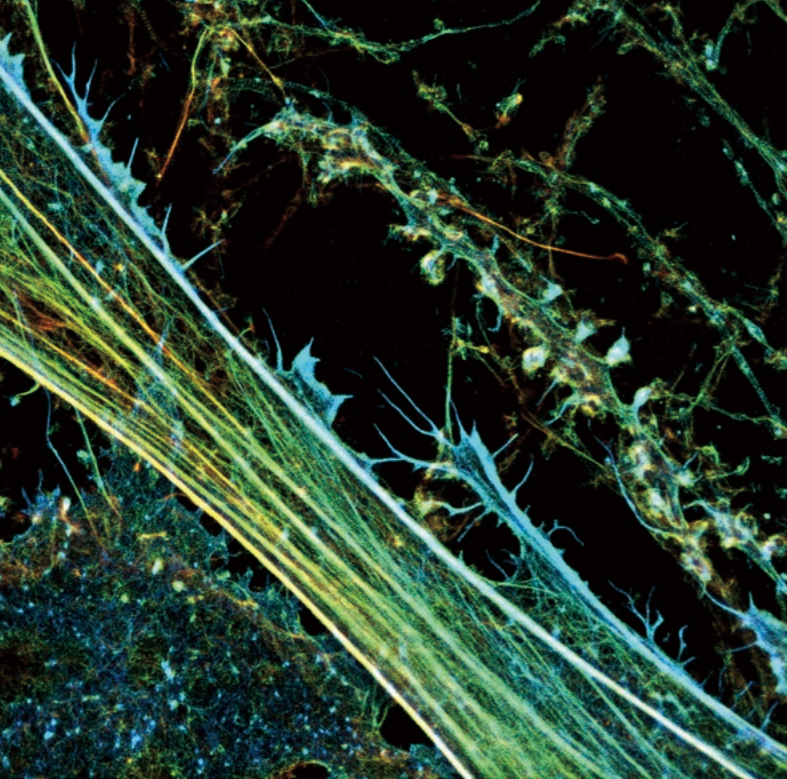

a: Hippocampal neurons and glia in culture
3D-STORM imaging of actin labeled with Alexa Fluor® 647 Phalloidin using depth-code pseudo color. Image "a" shows four types of actin organization, from bottom left to top right: the cell body of a neuron, a glial cell with stress fibers, a neuronal dendrite with spines, and an axon.
Photos courtesy of: Dr. Christophe Leterrier, NeuroCyto team, NICN CNRS-AMU UMR7259, Marseille, France

b: Growth cone of a neuron in culture

c: Glia in a neuronal culture

d: COS cells

N-STORM

Experience the nanoscale universe

STochastic Optical Reconstruction Microscopy (STORM) reconstructs a super-resolution image by combining precise localization information for individual fluorophores in complex fluorescent microscope specimens. The N-STORM takes advantage of Nikon's powerful Ti2-E inverted microscope and applies high-precision multi-color localization and reconstruction in three dimensions (xyz) to enable super-resolution imaging at tenfold the resolution of conventional light microscopes (up to 20 nm in xy). This powerful technology enables visualization of molecular interactions and organizations at the nanoscopic scale, opening up new worlds of scientific understanding.

- ❖ 10 times the resolution of conventional light microscopes in x, y and z directions
- ❖ Dynamic super resolution imaging at the molecule level
- ❖ Multi-color imaging capability
- ❖ High definition, high density images
- ❖ Large image acquisition area

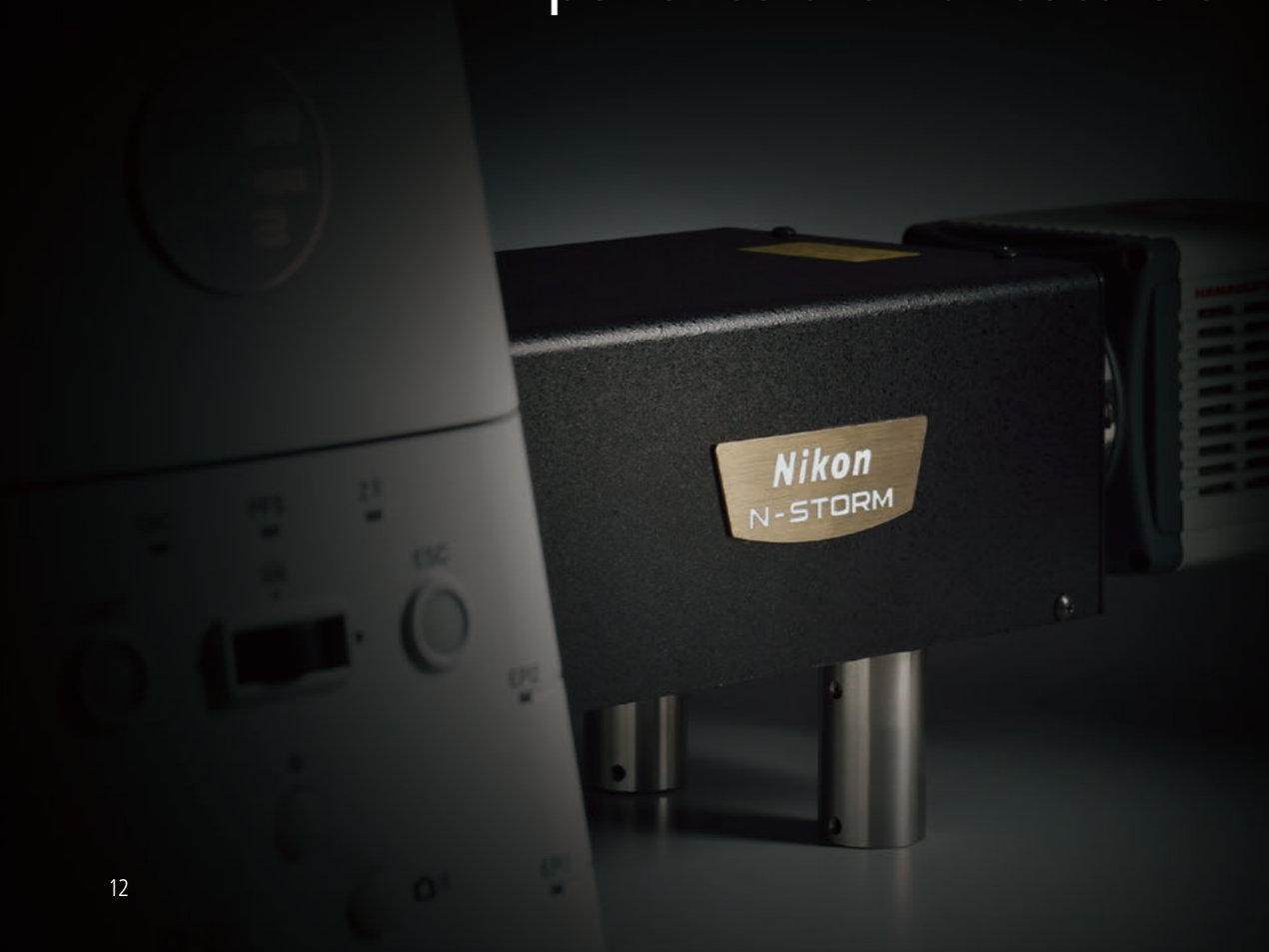

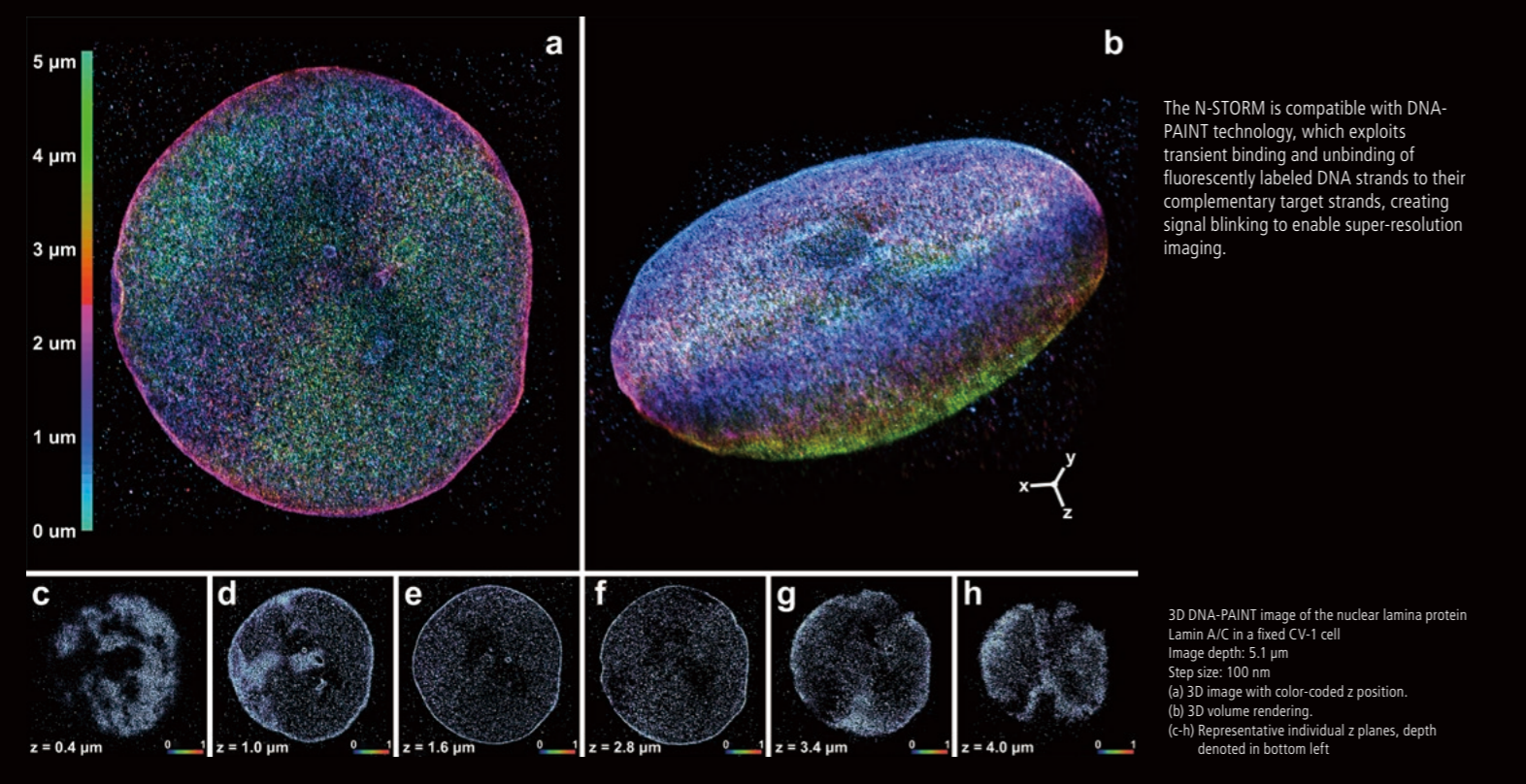

Tenfold increased resolution in x, y and z

Up to 50 nm axial resolution

In addition to lateral super-resolution, the N-STORM utilizes proprietary methods to achieve a tenfold enhancement in axial resolution over conventional light microscopes and provide nanoscale information in 3D. The 3D-Stack function allows multiple 3D-STORM images from different Z positions to be captured and stitched into one image to create thicker STORM images.

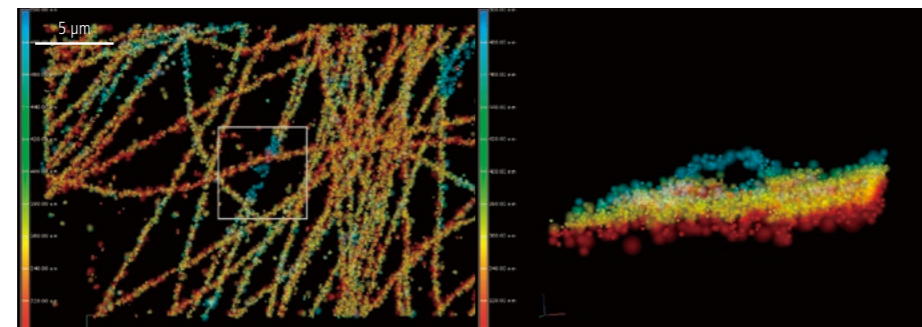

Tubulin of BSC-1 cell labeled with Alexa Fluor[®] 647

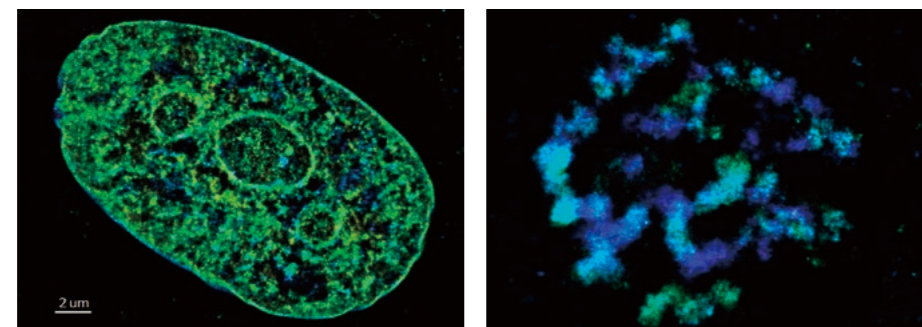

A human fibroblast labeled with EdU-Alexa Fluor[®] 647 to visualize DNA with 3D-STORM.
 Photo courtesy of: Jason Otterstrom, Ph.D., Melike Lakadamyali, Ph.D., The Institute of Photonic Sciences (ICFO), Castelldefels, Spain

Primary cell culture of Drosophila brain
 3D-STORM image of EdU-labeled DNA in Drosophila melanogaster neuroblast
 Photo courtesy of: Anna Oddone, Ph.D., Melike Lakadamyali, Ph.D. group, The Institute of Photonic Sciences (ICFO), Castelldefels, Spain

Up to 20 nm lateral resolution

The N-STORM utilizes high-precision localization information from thousands of individual fluorophores present in a field of view to create breathtaking "super-resolution" images, exhibiting spatial resolution 10 times greater than conventional light microscopes.

N-STORM images

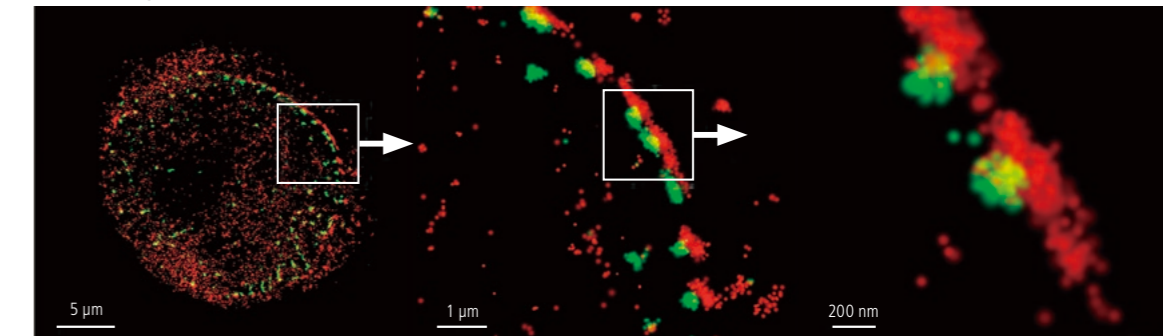

Conventional widefield images

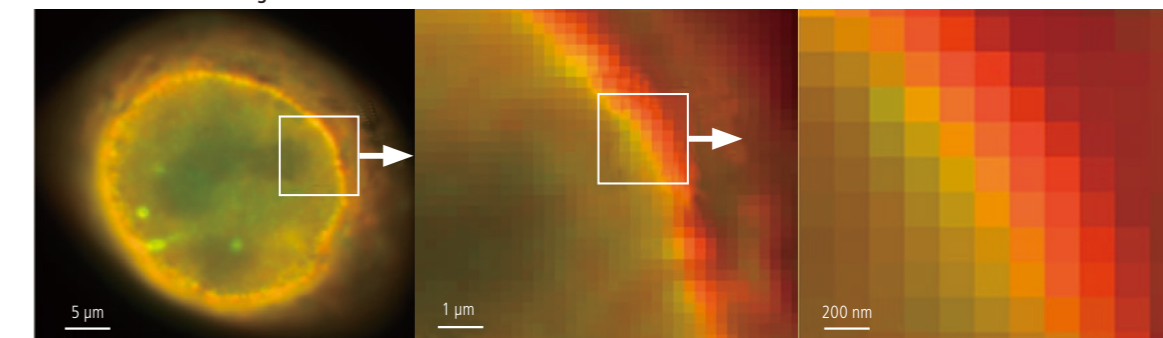

Human cervical cancer cells (HeLa S3) labeled with Alexa Fluor[®] 647 (NUP153) and ATTO 488 (TPR)
 Photos courtesy of: Dr. Michael W. Davidson, National High Magnetic Field Laboratory, Florida State University

N-STORM images

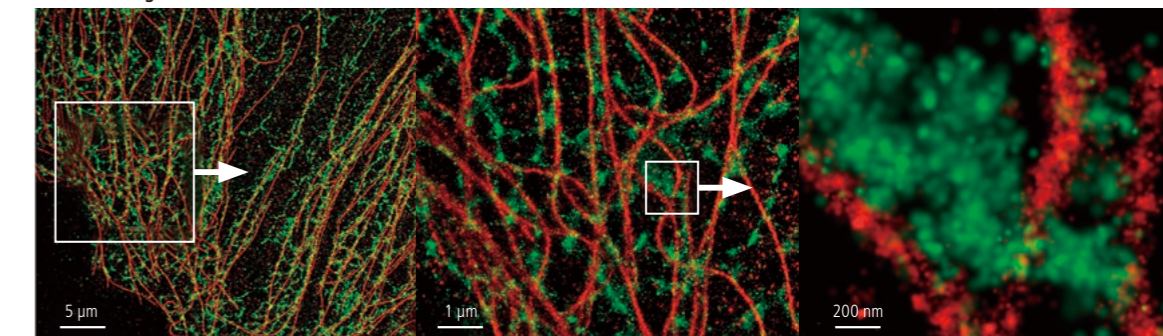

Conventional widefield images

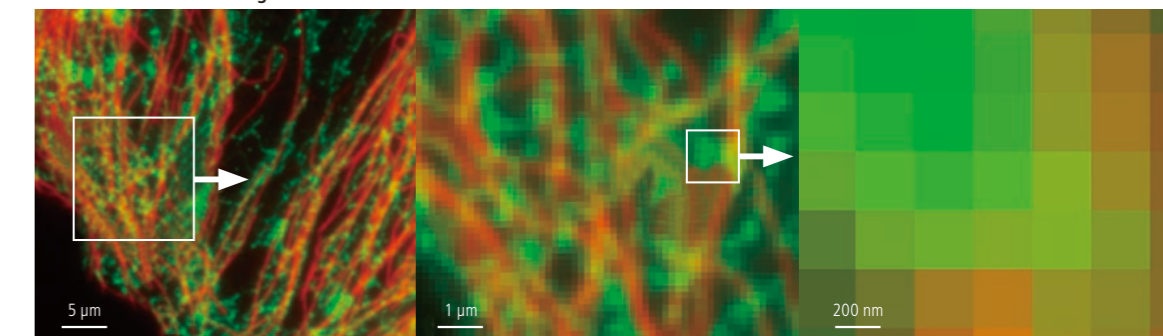

African green monkey kidney cells (BSC-1) labeled with Alexa Fluor[®] 647 (Tubulin) and ATTO 488 (Calreticulin)
 Photos courtesy of: Dr. Michael W. Davidson, National High Magnetic Field Laboratory, Florida State University

Dynamic super resolution imaging

Newly developed optics and illumination systems, optimized for sCMOS technology, have increased image acquisition speeds by up to 10 times. With acquisition times reduced from minutes to seconds*, dynamic events in live specimens can now be captured with molecular level resolution.

* Using high-speed mode (20 $\mu\text{m} \times 20 \mu\text{m}$ imaging area)

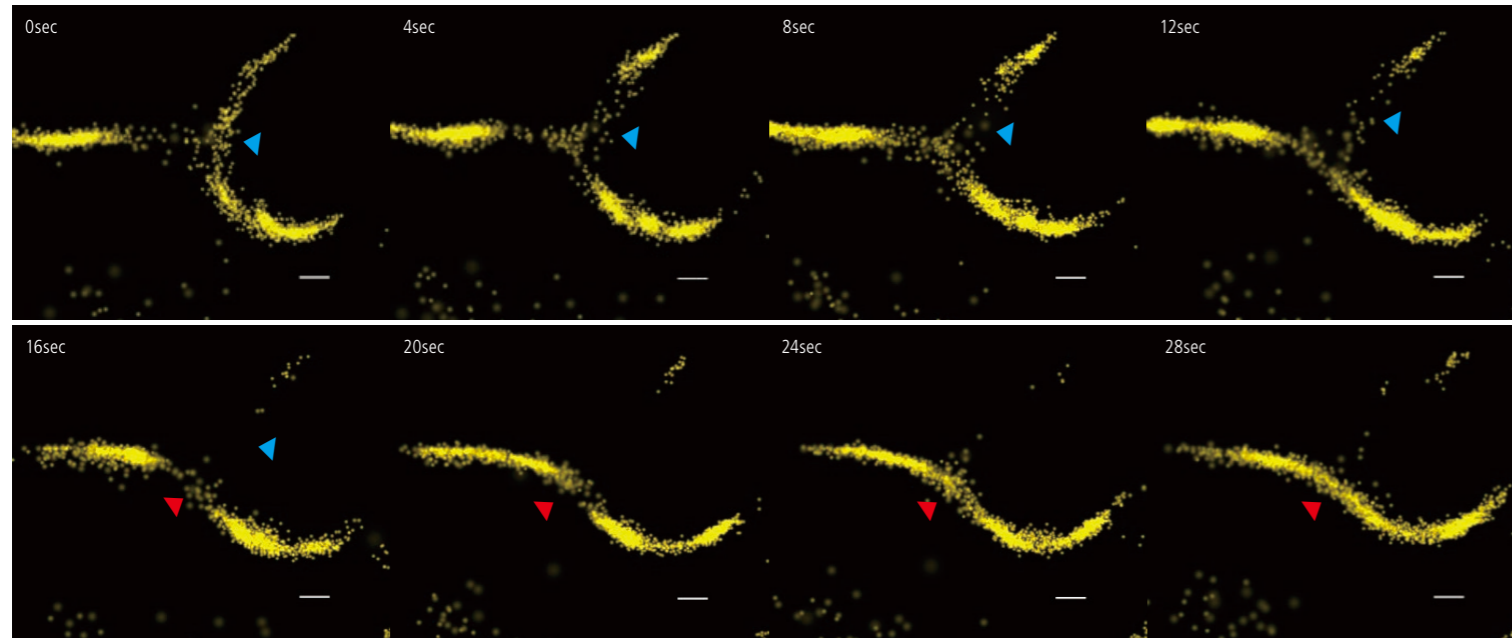

Time-lapse STORM images of African green monkey kidney cell (BSC-1) labeled with Mito-Tracker Red (Mitochondria).
Imaging speed: 500 fps
28 sec time-lapse imaging with 2 sec interval
Scale bar: 0.2 μm

Multi-color imaging capability

Multi-color super-resolution imaging can be carried out using both activator-reporter pairs for sequential activation imaging and activator-free labels for continuous activation imaging. This flexibility allows users to easily gain critical insights into the localization and interaction properties of multiple proteins at the molecular level.

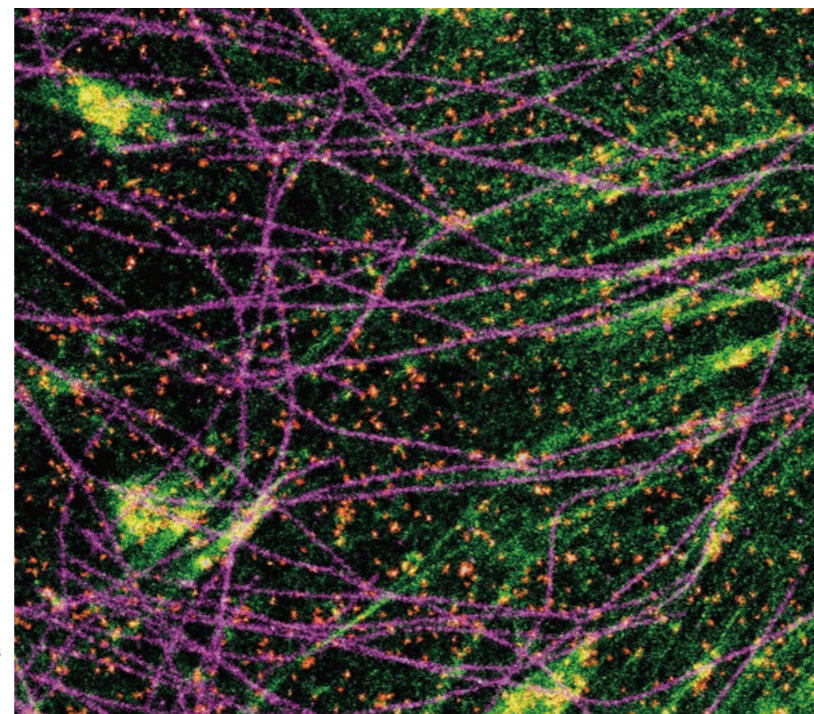

3-color STORM image of a CV-1 cell stained with antibodies against alpha-tubulin (Alexa Fluor[®] 647; magenta), caveolin (Alexa Fluor[®] 555; red), and with Alexa Fluor[®] 488-phalloidin (green) for f-actin.

High definition, high density images

Newly developed excitation optics and improved image acquisition rates provide increased molecule localization density, resulting in clearer images of macromolecular structures.

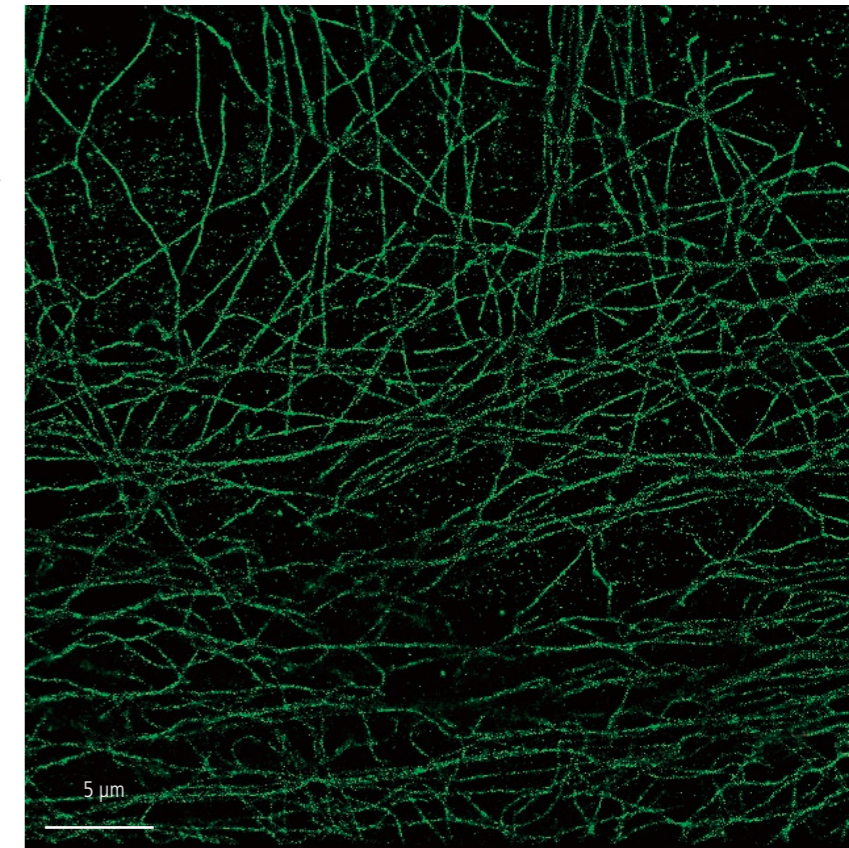

Tubulin of BSC-1 cell labeled with Alexa Fluor[®] 647, acquisition time: 20 seconds

Large image acquisition area

New intermediate zoom lenses in the imaging system have been developed and optimized for a wide field of view. The wide-view mode achieves 80 $\mu\text{m} \times 80 \mu\text{m}$, a 4-fold increase in imaging area compared to previous models.

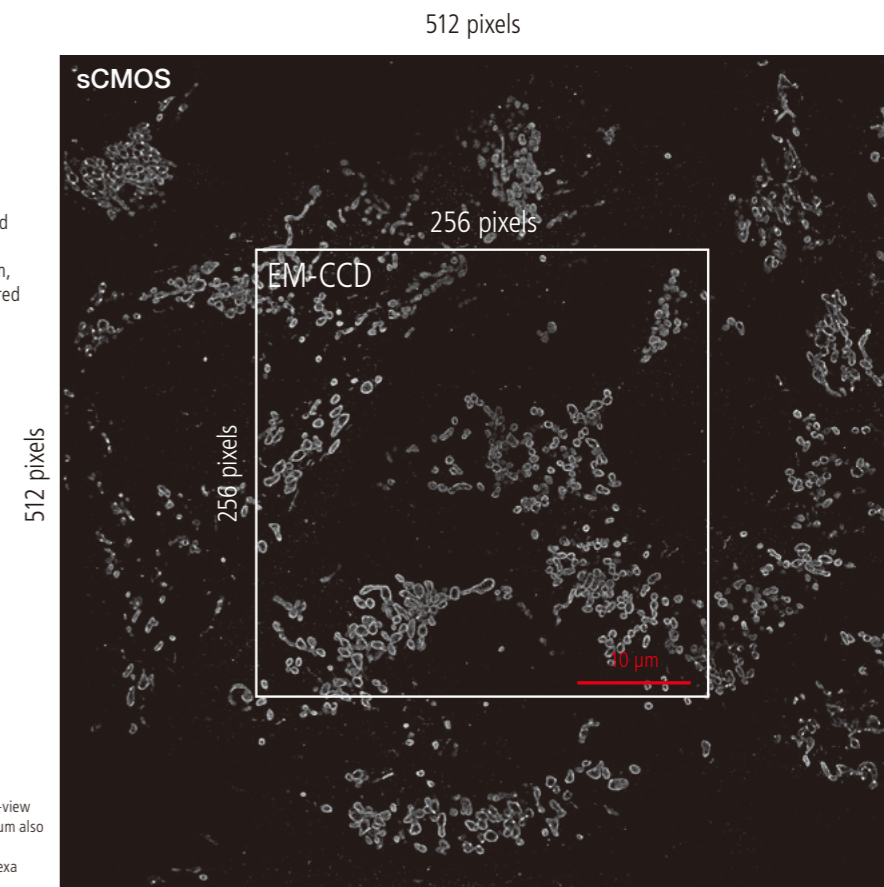

4 times wider imaging area, 80 $\mu\text{m} \times 80 \mu\text{m}$ (wide-view mode). Conventional imaging area of 40 $\mu\text{m} \times 40 \mu\text{m}$ also shown for comparison.
Sample: Mitochondria TOM20 conjugated with Alexa Fluor[®] 647

The principle of STochastic Optical Reconstruction Microscopy

STochastic Optical Reconstruction Microscopy (STORM) reconstructs a super-resolution image by combining high-accuracy localization information of individual fluorophores in three dimensions and multiple colors

N-STORM uses stochastic activation of relatively small numbers of fluorophores using very low-intensity light. This random stochastic "activation" of fluorophores allows temporal separation of individual molecules, enabling high precision Gaussian fitting of each fluorophore image in XY. By utilizing special 3D-STORM optics, N-STORM can also localize individual molecules along the Z-axis with high precision. Computationally combining molecular coordinates in three dimensions results in super-resolution 3D images of the nanoscopic world.

Reconstruction of N-STORM images using localization information of individual fluorophores

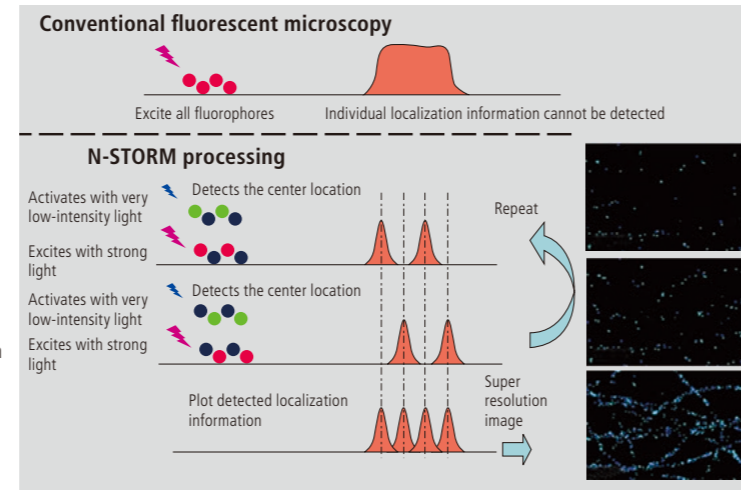

High-precision Z-axis position detection

Using a cylindrical lens that asymmetrically condenses light beams in either X or Y direction, Z-axis molecule locations can be determined with an accuracy of about 50 nm. Location in Z is determined by detecting the orientation of the astigmatism-induced stretch in the X or Y direction and the size of the out-of-focus point images. 3D fluorescent images can be reconstructed by combining the determined Z-axis location information with XY-axis location information.

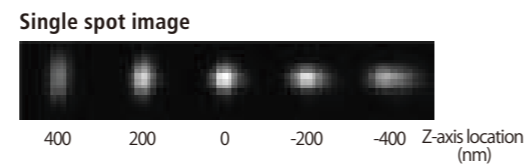

Variety of photoswitchable probes and labeling approaches for high localization accuracy

Various types of activator-reporter pairs and activator-free labels are available. The activator-reporter dye pair approach provides consistent localization accuracy between channels by leveraging the same reporter dye for different channels. Each dye pair consists of an activator dye and reporter dye, with the activator dye regulating the activation state of the reporter dye. Activator-free labels consist of imaging dye only, enabling simple labeling and sample preparation techniques such as conventional indirect immunofluorescence using conventional dye-conjugated antibodies.

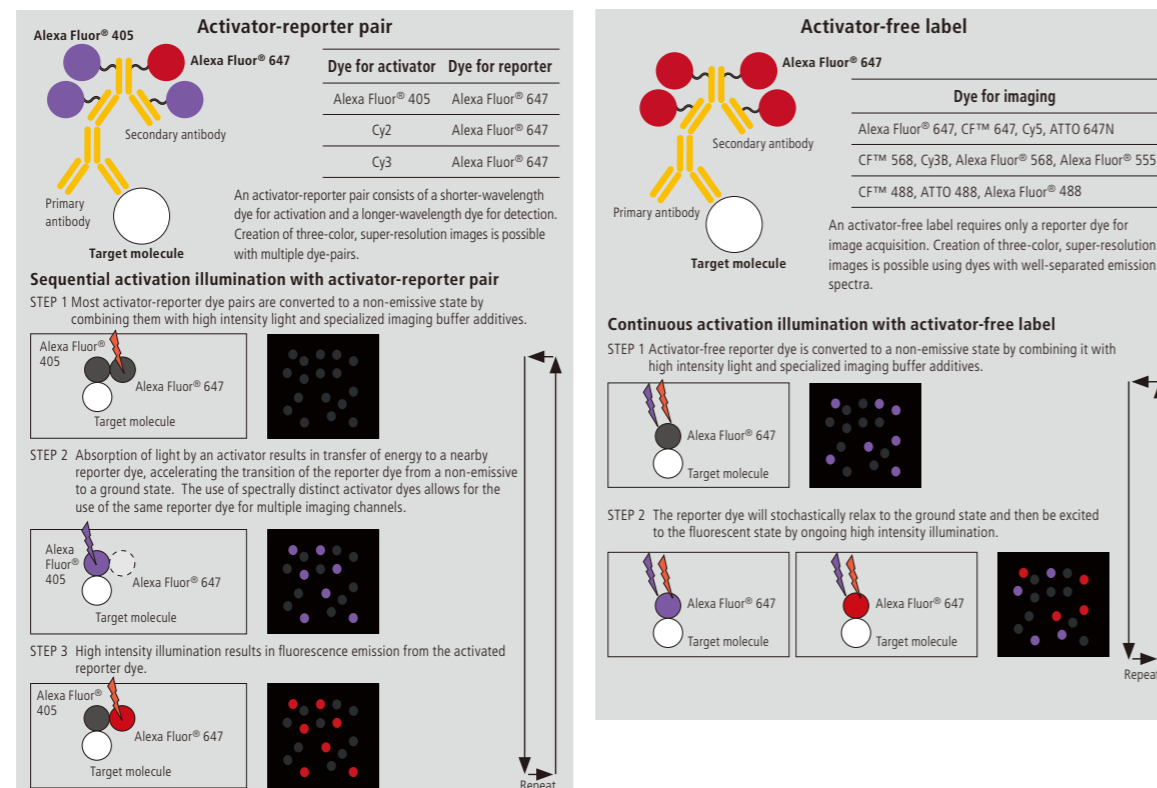

N-STORM system diagram

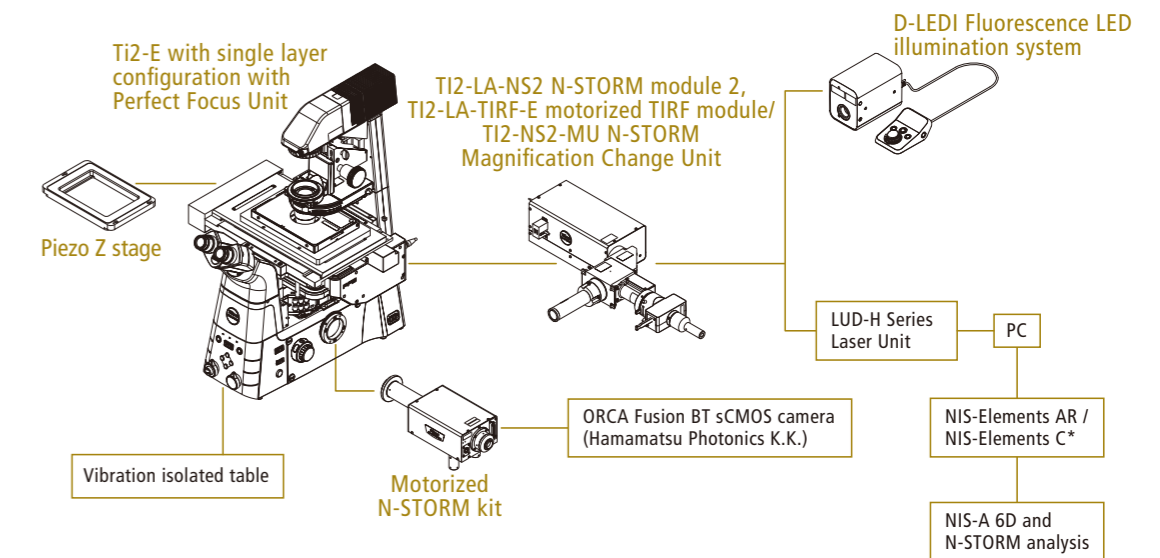

* Required when used with confocal system

N-STORM Specifications

XY resolution	Approximately 20 nm
Z-axis resolution	Approximately 50 nm
Imaging mode	2D-STORM (normal mode, continuous mode) 3D-STORM (normal mode, continuous mode), 3D-Stack function
Max. field of view	80 μm x 80 μm
Acquisition speed	Up to 500 Hz
Multi-color imaging	Up to 3 colors
Compatible laser	LUD-H series laser unit 405 nm, 488 nm, 561 nm, 640 nm
Compatible microscope	Motorized inverted microscope ECLIPSE Ti2-E Perfect Focus System Motorized XY stage with encoders Piezo Z stage
Objective	CFI SR HP Plan Apochromat Lambda S 100XC SII (NA1.35) CFI SR HP Apochromat TIRF 100XC Oil (NA 1.49) CFI SR HP Apochromat TIRF 100XAC Oil (NA 1.49) CFI HP Plan Apochromat VC 100X Oil (NA 1.40)
Camera	ORCA Fusion BT sCMOS camera (Hamamatsu Photonics K.K.)
Software	NIS-Elements AR/NIS-Elements C (for Confocal Microscope AX/AX R) Both require additional software modules NIS-A 6D and N-STORM Analysis
Operating conditions	20 °C to 25 °C (± 0.5 °C)

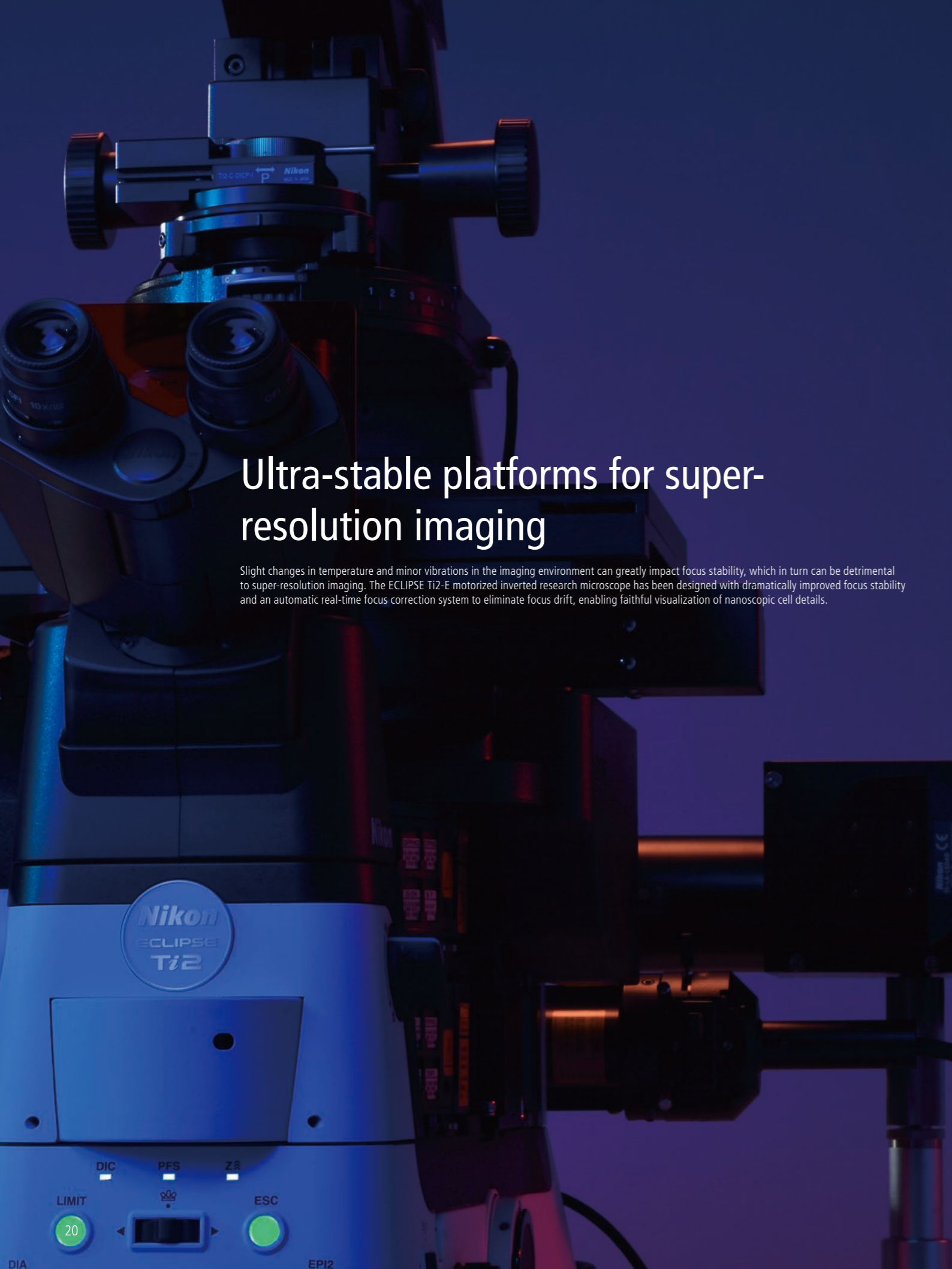

Ultra-stable platforms for super-resolution imaging

Slight changes in temperature and minor vibrations in the imaging environment can greatly impact focus stability, which in turn can be detrimental to super-resolution imaging. The ECLIPSE Ti2-E motorized inverted research microscope has been designed with dramatically improved focus stability and an automatic real-time focus correction system to eliminate focus drift, enabling faithful visualization of nanoscopic cell details.

N-SIMS/N-STORM



Real-time focus correction with PFS

The Perfect Focus System (PFS) maintains focus by automatically tracking and maintaining the desired Z position. PFS corrects focus drift, caused by minute temperature changes and vibrations, in real time. The detector portion of the PFS is separated from the nosepiece to minimize mechanical load and heat transfer, further reducing the potential for Z-drifts.

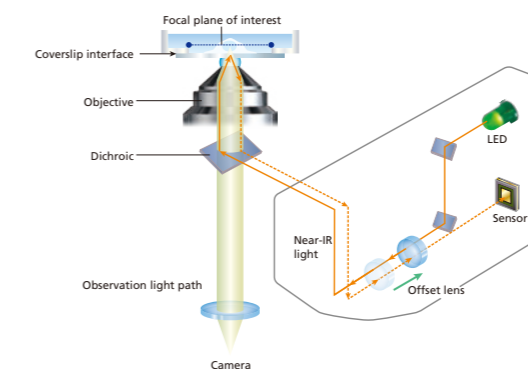

High-stability Z-focusing mechanism

The durable body of the Ti2-E provides a highly stable platform for super-resolution microscopes. The Ti2-E minimizes vibrations by downsizing the Z-focusing mechanism and positioning it adjacent to the nosepiece, providing the superior Z-focusing precision and stability required for super-resolution imaging.



Auto correction collar

Super-resolution imaging is highly sensitive to spherical aberrations. An automatic correction collar enables easy and precise correction collar adjustment to compensate for spherical aberrations, ensuring consistently high quality super-resolution images.





Highest performance optics for super-resolution imaging

Nikon has developed dedicated objectives for super-resolution imaging to realize bright and precise nanoscale images. The SR objectives are aligned and inspected using wavefront aberration measurement technologies to ensure the lowest possible asymmetric aberration and superb optical performance required for super-resolution imaging.

N-SIMS / N-STORM

Silicone immersion objectives

Silicone immersion objectives use high viscosity silicone oil with a refractive index close to that of live cells as an immersion liquid. Because of this improved refractive index compatibility, these objectives can provide improved photon collection capability and resolution when performing super-resolution imaging deeper into the specimen. They exhibit superior chromatic aberration correction and high transmittance over a broad range of wavelengths.



CFI SR HP Plan Apochromat
Lambda S 100XC Sil

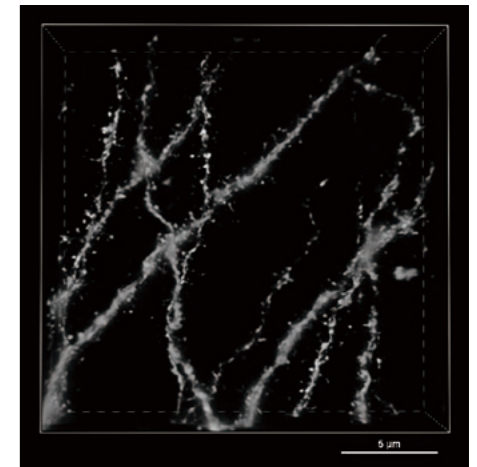

N-SIM image
Sample: Mouse brain section labeled with tdTomato expressing neurons

Silicon immersion objective

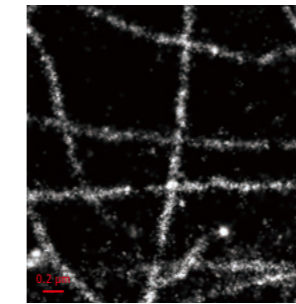

N-STORM images (approx. 6.5 μm depth)

Oil immersion objective

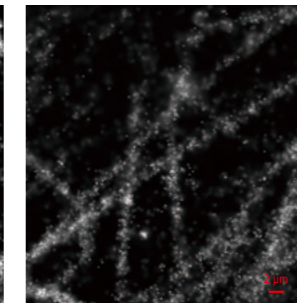

Left: CFI SR HP Plan Apochromat Lambda S 100XC Sil, Right: CFI SR HP Apochromat TIRF 100XC Oil

Oil immersion objectives

These objectives provide the high numerical apertures required for N-STORM imaging. The HP objectives are compatible with the ultrahigh power lasers required for inducing rapid photoswitching of fluorophores. They provide improved axial chromatic aberration correction to achieve the highest level of precision in localization and image alignment for 3D multi-color STORM imaging.



CFI SR HP Apochromat
TIRF 100XC Oil



CFI HP Plan Apochromat
VC 100X Oil



CFI SR HP Apochromat
TIRF 100XC AC Oil



CFI SR Plan Apochromat
IR 60XC WI



CFI SR Plan Apochromat
IR 60XC AC WI

Water immersion objectives

These objectives correct chromatic aberration over a wide range of wavelengths up to near-IR, enabling high-resolution deep imaging of live cells. The AC-type objectives that support the Auto Correction Collar of the Ti2-E microscope allow precise and easy adjustment of the correction collar.

Dry objectives

The N-SIM S is compatible with dry objectives, making both super-resolution imaging and confocal imaging available without switching lenses. Low-magnification, wide field-of-view dry lenses enable high resolution observation even at the periphery of sample tissues.

*Dry objectives support 2D-SIM and 3D-SIM (slice reconstruction) only



CFI Plan Apochromat
Lambda 60XC



CFI Plan Apochromat
Lambda D 40XC

Model	Immersion	NA	W.D. (mm)	Correction collar
CFI SR HP Plan Apochromat Lambda S 100XC Sil	Silicone oil	1.35	0.31-0.29 (0.30*): 23°C, 0.30-0.28 (0.29*): 37°C	Manual
CFI SR HP Apochromat TIRF 100XC Oil	Oil	1.49	0.16-0.10 (0.12*): 23°C, 0.15-0.09 (0.12*): 37°C	Manual
CFI SR HP Apochromat TIRF 100XC AC Oil	Oil	1.49	0.16-0.10 (0.12*): 23°C, 0.15-0.09 (0.12*): 37°C	Auto
CFI HP Plan Apochromat VC 100X Oil	Oil	1.40	0.13	
CFI SR Plan Apochromat IR 60XC WI	Water	1.27	0.18-0.16 (0.17*)	Manual
CFI SR Plan Apochromat IR 60XC AC WI	Water	1.27	0.18-0.16 (0.17*)	Auto
CFI Plan Apochromat Lambda 60XC	Dry	0.95	0.21-0.11 (0.15*)	Manual
CFI Plan Apochromat Lambda D 40XC	Dry	0.95	0.25-0.16 (0.21*)	Manual

*With cover glass thickness of 0.17 mm

Unified acquisition and analysis software platform

NIS-Elements, Nikon's unified software platform, provides an intuitive workflow for super-resolution imaging. Combined with graphical programming tools such as JOBS and illumination sequence, as well as powerful analysis and visualization tools, NIS-Elements creates a comprehensive operating environment that can be fully customized for a variety of application requirements.

N-SIMS / N-STORM

Image Acquisition

N-SIMS

Image acquisition setting

The N-SIMS can easily switch between 2D-SIM, 3D-SIM and TIRF-SIM modes. The JOBS flexible imaging sequence option enables seamless image acquisition between the N-SIMS, N-STORM and confocal microscopes.



Display & Processing

N-SIMS

Image reconstruction

Auto settings allow the software to automatically select the most appropriate reconstruction parameters for acquired images in order to reconstruct N-SIMS images. Users can further optimize reconstruction by manually adjusting these parameters. The reconstruction view allows users to preview the results of the selected reconstructed parameters on the current/selected frame, enabling efficient reconstruction parameter determination.

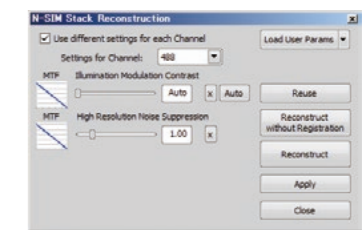

N-STORM

Image acquisition setting

The N-STORM can easily switch between 2D-STORM and 3D-STORM image acquisition modes.

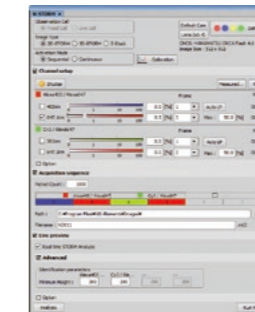

N-STORM

Batch processing analysis

Multiple N-STORM images can be simultaneously analyzed.

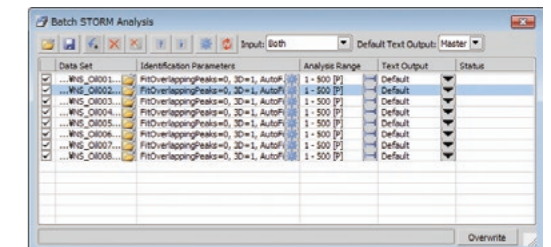

Real-time display of localizations per frame

During N-STORM image acquisition, the number of localized fluorescent molecules is displayed in real time using images and graphs. Clicking the Auto LP (Auto Laser Power) button automatically adjusts laser power, depending on the number of localized fluorescent spots.

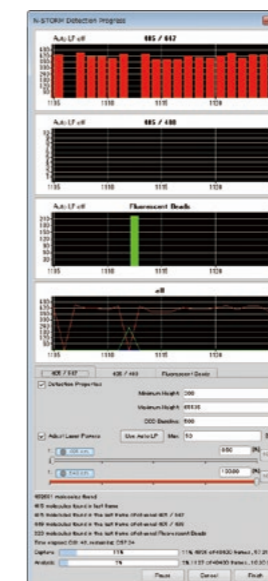

3D display

A major feature of the N-STORM is 3D super-resolution image acquisition and analysis. Acquired images can be displayed at any angle after analysis.

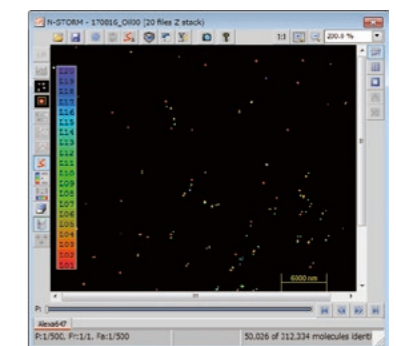

Explore the nano world with N-SIMS / N-STORM

Seamless switching between imaging modalities for multi-scale experiments

Combining the N-SIMS and N-STORM with a single Ti2-E inverted microscope expands the functionality of each individual technology. The N-SIMS enables acquisition of thicker volume images, thereby providing a more comprehensive molecular landscape for interpreting the single-molecule level data acquired by the N-STORM.

The N-SIMS and/or N-STORM can be further combined with a confocal microscope such as the AX. A desired location in a sample can be specified in a low-magnification/large FOV confocal image and acquired in super-resolution by simply switching the imaging method. Combining a confocal microscope with a super-resolution system can provide a method for gaining larger contextual views of the super-resolution information.

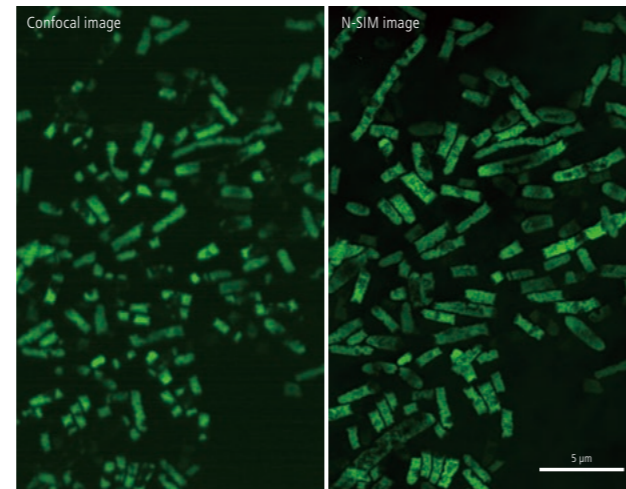

E. coli (XLI-Blue) expressing SGFP2
Photos courtesy of: Drs. Takahisa Suzuki and Ikuo Wada, Fukushima Medical University School of Medicine

Mouse brain section (hippocampus CA1 region) immunostained against CB1 cannabinoid receptors using Alexa Fluor® 647. With STORM imaging, the membranes of hollow axon terminals are more sharply observed.
Photos courtesy of: Barna Dudok Ph.D., Laszlo Barna Ph.D., and Istvan Katona Ph.D., Laboratory of Molecular Neurobiology, Institute of Experimental Medicine of the Hungarian Academy of Sciences

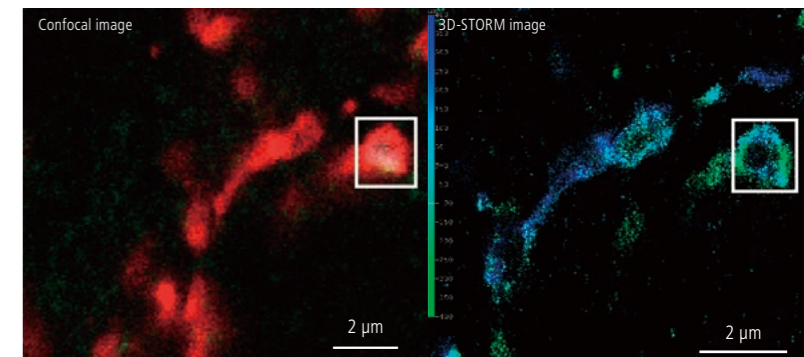

HEK cells expressing an eGFP-CB1 fusion construct were imaged with both confocal and 3D-STORM modules on the same imaging platform. CB1 was counter-stained using secondary antibodies labeled with a Cy3-Alexa Fluor® 647 tandem dye pair for STORM imaging. GFP fluorescence was imaged using the confocal module. Membrane structures are visible at a higher resolution in the STORM image than in the confocal image. In addition, intracellular membrane structures that are not visible in the confocal image due to limitations in dynamic range and resolution are visible in the STORM image.
Photos courtesy of: Barna Dudok Ph.D., Laszlo Barna Ph.D., and Istvan Katona Ph.D., Laboratory of Molecular Neurobiology, Institute of Experimental Medicine of the Hungarian Academy of Sciences

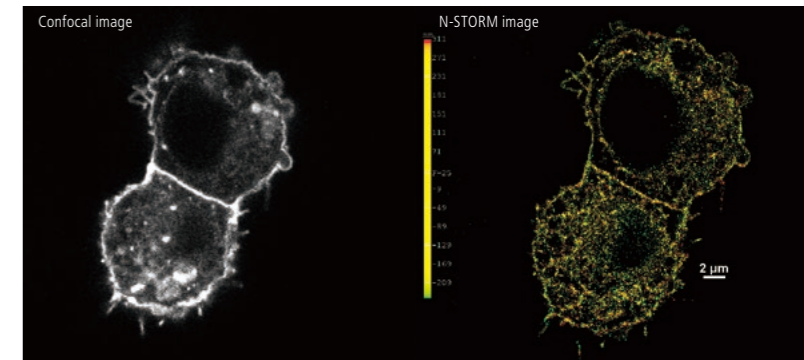

"Simultaneous equipment of the A1+ Confocal Microscope and the N-SIM Super Resolution Microscope with a single imaging system enables multi-mode analysis. This multi-mode combination is advantageous in the study that requires wide and detailed views in a consistent manner. To analyze giant cells such as cultured mature osteoclasts with diameters of a few hundred microns, the user can acquire an image with a wide view using the A1+, select the area to be observed from that wide image, then switch to the N-SIM for ultrafine observation. Electron microscopy had been commonly used to observe podosomes that assemble to form ring-like structures called actin rings that are functionally associated with cellular adhesion and locomotion of osteoclasts. The N-SIM optically resolves individual podosomes, and enables the quantitative evaluation of osteoclast functions by analysis of the temporal and spatial dynamics of podosomes."

Dr. Tadahiro Iimura

Division of Bio-Imaging, Proteo-Science Center (PROS),
Division of Analytical Bio-Medicine, Advanced Research Support Center (ADRES), Ehime University

"We found that CCR5, the target molecule for treatment of HIV infections, exists in osteoclasts, and that the functional loss of CCR5 impairs the bone-resorption activity of osteoclasts, resulting in a lower incidence of osteoporosis.* This finding suggests that CCR5-antagonist treatment may prevent bone-destructive diseases such as osteoporosis as well as HIV transmission."
*Nature Communications DOI: 10.1038/s41467-017-02368-5

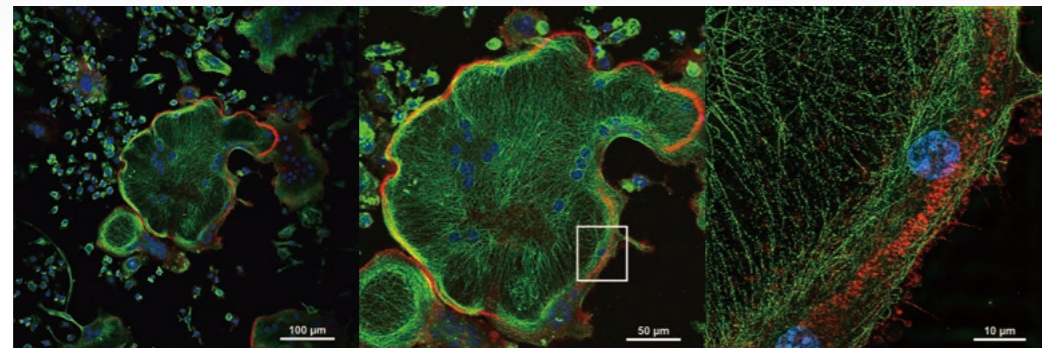

Podosome (actin) labeled with Alexa Fluor® 568 (red), tubulin labeled with Alexa Fluor® 488 (green) and nucleus labeled with DAPI (blue)
Left: Large FOV confocal image, Middle: Projection of Z-stack confocal images, Right: Super-resolution image
Photos courtesy of: Drs. Ji-Won Lee and Tadahiro Iimura, Division of Bio-Imaging, Proteo-Science Center (PROS), Ehime University



"STORM imaging is the most important tool for our research as it is the only technique that allows us to measure the precise position and distribution of important signaling molecules within the chemical synapse on the nanoscale. But this data alone is like looking at stars in a dark sky. We need to use confocal microscopy to show in which context these molecular changes are taking place. After the physiological experiments we use confocal imaging for the morphological characterization of the cell type and the synapse. Then, we switch to STORM mode to gather information on the signaling molecules responsible for the physiological signaling. In this way we can correlate the molecular data, the anatomical data and the physiological data from the very same synapse. And this is very exciting!"

Dr. Istvan Katona

Laboratory of Molecular Neurobiology, Institute of Experimental Medicine of the Hungarian Academy of Sciences

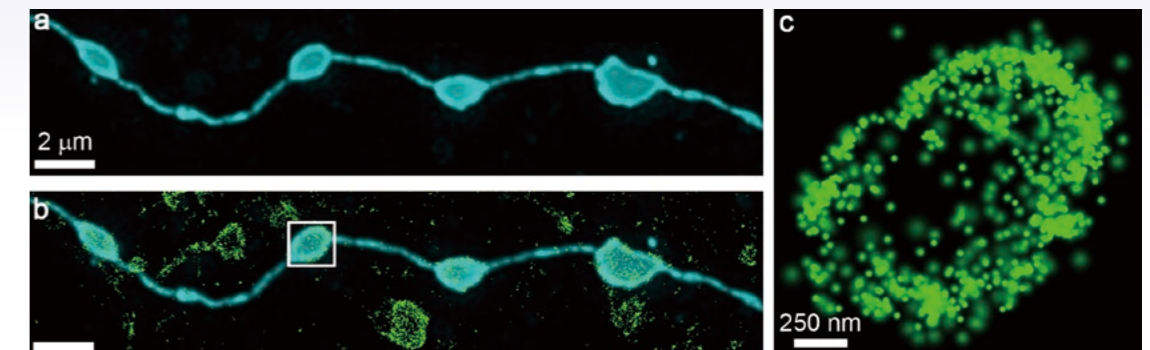

Correlated confocal-STORM images demonstrating cannabinoid receptor localizations (green) on axon terminals of a hippocampal GABAergic interneuron (cyan). The images were taken on a combined N-STORM/C2 confocal system
Photos courtesy of: Dr. Barna Dudok, Laboratory of Molecular Neurobiology, Institute of Experimental Medicine of the Hungarian Academy of Sciences

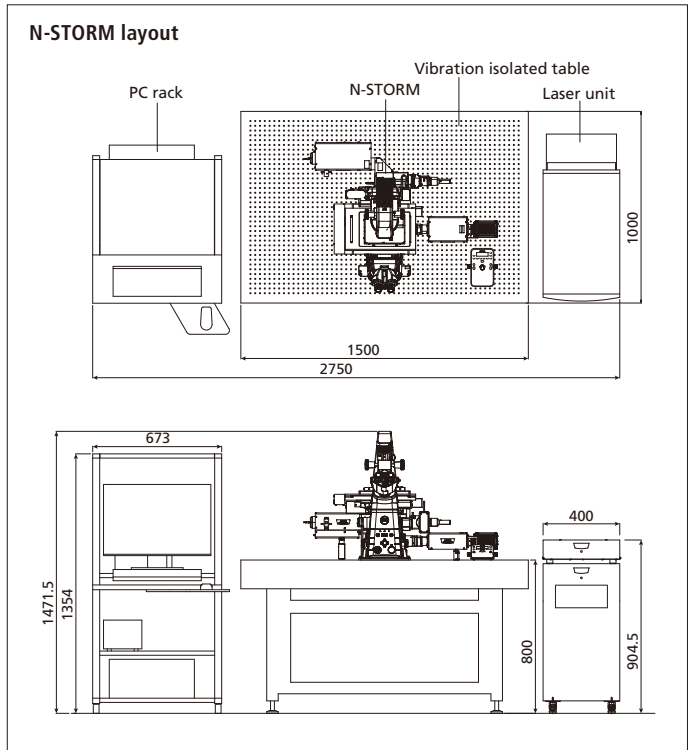
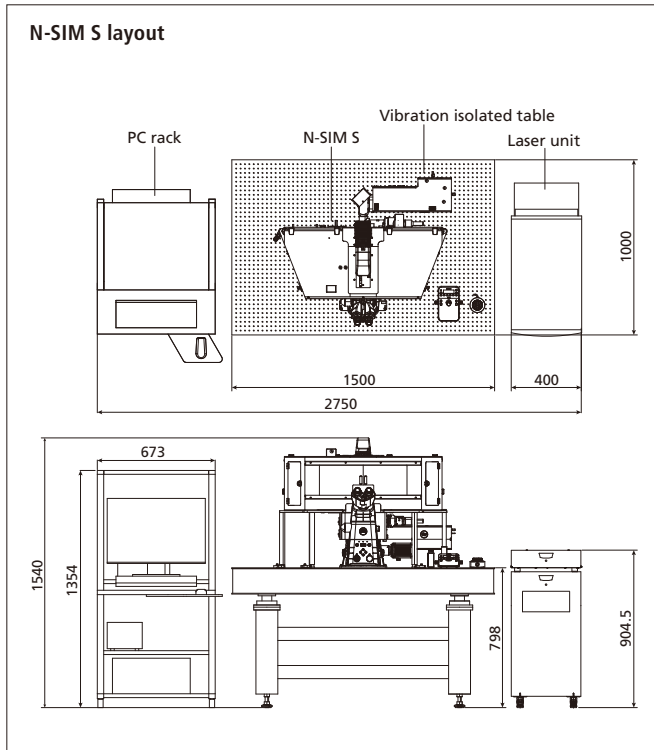

Unit: mm

Specifications and equipment are subject to change without any notice or obligation on the part of the manufacturer. July 2024 ©2024 NIKON CORPORATION

	WARNING
TO ENSURE CORRECT USAGE, READ THE CORRESPONDING MANUALS CAREFULLY BEFORE USING YOUR EQUIPMENT.	

Monitor images are simulated.
 Alexa Fluor® and Cy are registered trademarks of Thermo Fisher Scientific, Inc.
 Company names and product names appearing in this brochure are their registered trademarks or trademarks.
 N.B. Export of the products* in this brochure is controlled under the Japanese Foreign Exchange and Foreign Trade Law. Appropriate export procedure shall be required in case of export from Japan.
 *Products: Hardware and its technical information (including software)

WARNING-LASER RADIATION
 AVOID EXPOSURE TO BEAM
CLASS 3B LASER PRODUCT
 Total Power 500mW MAX.
 CW 400~700nm
 IEC/EN60825-1 : 2007, 2014

Complies with FDA performance standards for laser products except for deviations pursuant to Laser Notice No. 50, dated June 24, 2007

DANGER-VISIBLE AND INVISIBLE LASER RADIATION AVOID EYE OR SKIN EXPOSURE TO DIRECT OR SCATTERED RADIATION
CLASS 4 LASER PRODUCT
 Total Power 1500mW MAX.
 CW 370~700nm
 IEC/EN60825-1 : 2007, 2014

Complies with FDA performance standards for laser products except for deviations pursuant to Laser Notice No.50 dated June 24, 2007.



NIKON CORPORATION

Head office
 1-5-20, Nishiio, Shinagawa-ku, Tokyo 140-8601, Japan
<https://www.healthcare.nikon.com/en/>

Manufacturer
 471, Nagaodai-cho, Sakae-ku, Yokohama, Kanagawa 244-8533, Japan

Nikon Instruments Inc.
 1300 Walt Whitman Road, Melville, N.Y. 11747-3064, U.S.A.
 phone: +1-631-547-8500; +1-800-52-NIKON (within the U.S.A. only)
 fax: +1-631-547-0299
<https://www.microscope.healthcare.nikon.com/>

Nikon Europe B.V.
 Stroombaan 14, 1181 VX Amstelveen, The Netherlands
 phone: +31-20-7099-000
https://www.microscope.healthcare.nikon.com/en_EU/

Nikon Precision (Shanghai) Co., Ltd.
 CHINA phone: +86-21-6841-2050 fax: +86-21-6841-2060
 (Beijing branch) phone: +86-10-5831-2028 fax: +86-10-5831-2026
 (Guangzhou branch) phone: +86-20-3882-0550 fax: +86-20-3882-0580
<https://www.nikon-precision.com.cn/>

Nikon Canada Inc.
 CANADA phone: +1-905-625-9910 fax: +1-905-602-9953

Nikon France, Succursale de Nikon Europe B.V.
 FRANCE phone: +33-1-4516-4516

Nikon Deutschland, Zweigniederlassung der Nikon Europe B.V.
 GERMANY phone: +49-211-9414-888

Nikon Italy, Branch of Nikon Europe B.V.
 ITALY phone: +39-055-300-9601

Nikon Europe B.V., Amstelveen, Zweigniederlassung Schweiz (Egg/ZH)
 SWITZERLAND phone: +41-43-277-2867

Nikon UK, Branch of Nikon Europe B.V.
 UNITED KINGDOM phone: +44-208-247-1717

Nikon Österreich, Zweigniederlassung der Nikon Europe B.V.
 AUSTRIA phone: +43-1-972-6111

Nikon Singapore Pte. Ltd.
 SINGAPORE phone: +65-6559-3651 fax: +65-6559-3668

Nikon Australia Pty Ltd
 AUSTRALIA phone: +61-2-8767-6900

Nikon Instruments Korea Co., Ltd.
 KOREA phone: +82-2-6288-1900 fax: +82-2-555-4415

Nikon India Private Limited
 INDIA phone: +91-124-4688-500