



Shedding New Light On **MICROSCOPY**



Microscope objectives

Our objectives help you focus on yours

Nikon is a leader in the development and manufacture of optical and digital imaging technology for advanced science and clinical research. With over a 100-year history of optical excellence, Nikon is committed to accelerating innovation in science and clinical imaging to improve healthcare and provide a better quality of life.



Nikon's first microscope, released in 1925

The switch from traditional film photography to digital imaging was a major milestone in the field of microscopy, opening up new possibilities in both application and technology. Introduction of digital imaging spurred significant technological changes including the development of objectives with enhanced optical quality and functionality to meet the new demands. Objective lenses are arguably the most important element in the microscope and Nikon continues to invest heavily in the development of objectives to meet the changing demands of science. Explore some of Nikon's newest developments in high-performance objectives in this brochure.



In tireless pursuit of the highest quality

Each Nikon microscope objective is precision-crafted to provide the highest level of clarity and overall optical performance. World-class Nikon objectives, including the renowned CF160 infinity optical system, deliver brilliant images of breathtaking sharpness and clarity, from ultralow to the highest magnifications.

The initial melting process after blending glass raw materials

It Starts with the Glass

Nikon has been developing optical glass since its inception in 1917, and to this day, wholly owns and formulates all of its glass. Optical glass starts as an ingot (shown on right) which is formed by blending rare earth elements and repeated melting, shaping and slow cooling to achieve a target refractive index. The glass ingots are precision-cut, polished and coated to produce lens elements for the objective.

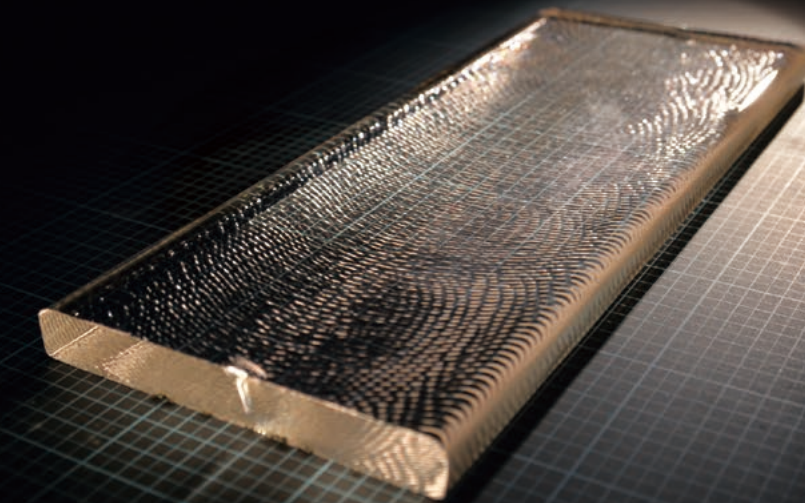

Mastering Excellence

The front lens of high-performance objectives is hand-polished by Nikon's most highly skilled experts (shown on left), a technique requiring more than a decade to master.

By controlling the entire manufacturing process from glass formulation to assembly and alignment of lens elements, Nikon ensures the highest quality and performance of its objectives.

Objectives Inspired by Your Science

Produced to exacting standards, Nikon's objectives provide exceptional detail and clarity. The highest level of image quality can be achieved whether it be for routine tasks or cutting-edge research.

Anti-Reflective Nano Crystal Coat

Nano Crystal Coat is ultra-low refractive index thin film technology that applies a nanoparticle film used for the projection lens of Nikon's semiconductor manufacturing equipment. An extremely high antireflection effect is achieved by forming a low-density film with particles of a few nanometers to a dozen nanometers. It also lowers the reflection of vertically incident light compared to conventional antireflection film, achieves extremely high transmittance in a wide wavelength range, has an unprecedented effect with respect to ghosting and flares caused by obliquely incident light.



Cleared Tissue Imaging



CFI90 20XC Glyc

Designed for deep imaging of cleared tissues

The unique CFI90 design results in an incredibly high N.A. while maintaining a large field of view and ultra-long working distance. Incorporates a correction collar for compensating for different refractive indices of clearing agents.

- NA: 1.00, WD: 8.20 mm
- Chromatic aberration correction from the visible to IR range
- High-transmittance Nano Crystal Coat
- Correction collar for spherical aberration correction

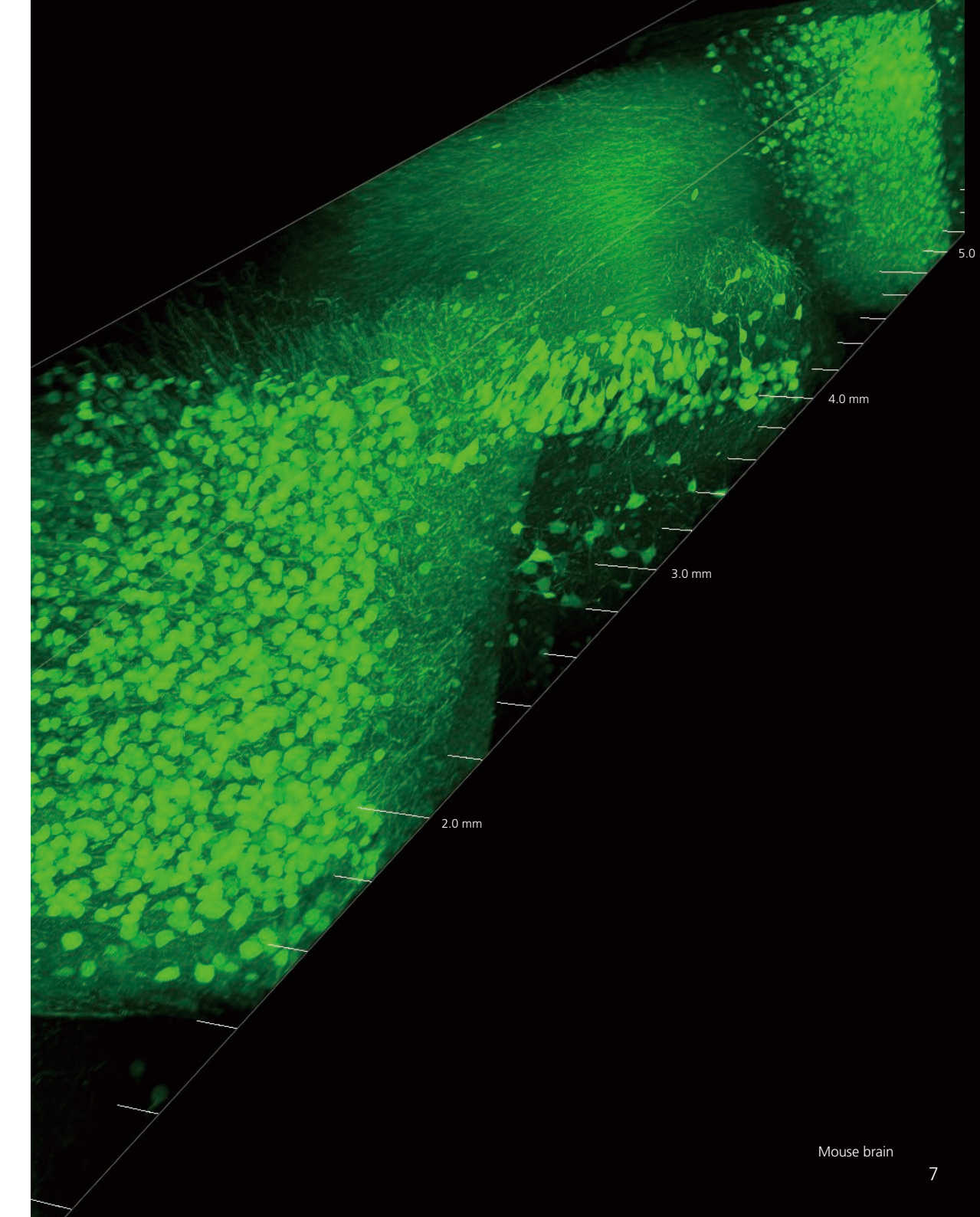

Cleared Tissue Imaging



CFI Plan Apo 10XC Glyc

Compatible with a wide range of immersion media and clearing agents

In addition to water and immersion oil, this objective lens is compatible with a variety of tissue clearing agents. The lens also features chromatic aberration correction over a broad spectral range and is compatible with the Ti2 inverted microscope.

- NA: 0.50, WD: 5.50 mm (upright) / 2.00 mm (inverted)
- Chromatic aberration correction from the visible to IR range
- High-transmittance Nano Crystal Coat
- Correction collar for spherical aberration correction

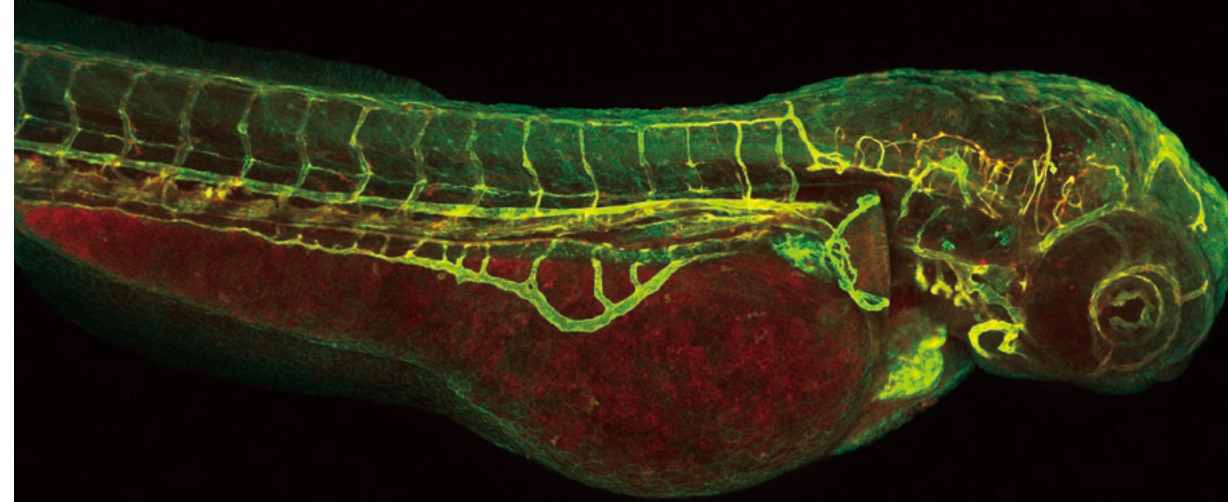

Zebrafish larva

Multiphoton Imaging



CFI75 Apo 25XC W 1300

Developed for deep brain applications

Best in class objective for multiphoton and electrophysiology applications. Offers ultra-long working distance and incredibly high N.A. for exceptional results every time.

- NA: 1.10, WD: 2.00 mm
- Chromatic aberration correction from the visible to near IR range
- High-transmittance Nano Crystal Coat
- Correction collar for spherical aberration correction

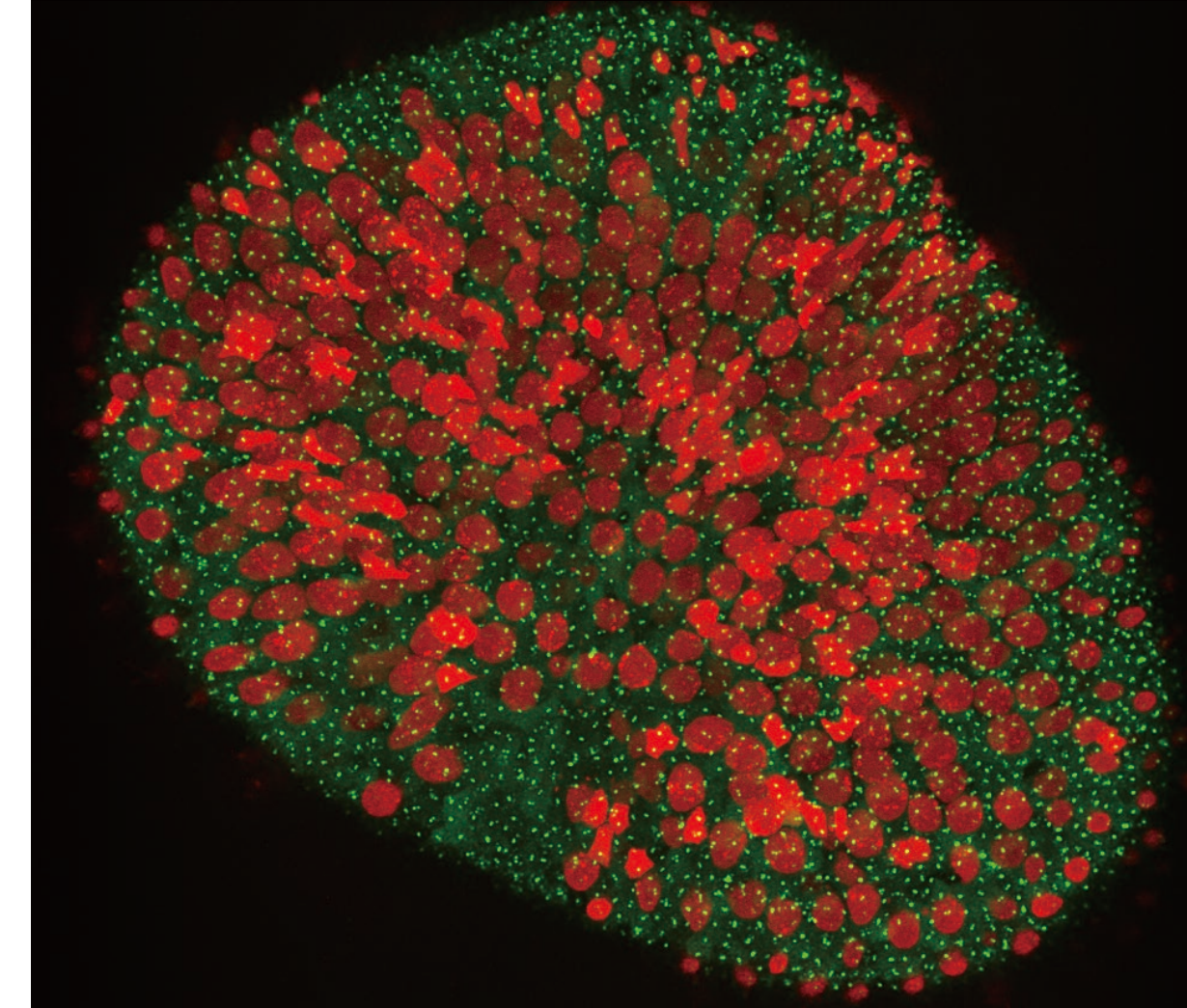

Inner Ear

Multiphoton Imaging



CFI75 Apochromat LWD 20XC W

Objective for large FOV multiphoton imaging

This objective can acquire bright multiphoton confocal images up to the edge of a large field of view of 22 mm. With a long working distance of 2.8 mm and a high numerical aperture of 1.00, it enables clear observation to deep within *in vivo* samples.

- NA: 1.00, WD: 2.8 mm
- Chromatic aberration correction from the visible to near IR range
- High-transmittance Nano Crystal Coat
- Correction collar for spherical aberration correction

Image courtesy of: Dr. L. Dubreil, Dr. J. Pichon and Pr MA Colle, CENN at PAnTher UMR703 INRAE/Oniris, Nantes France

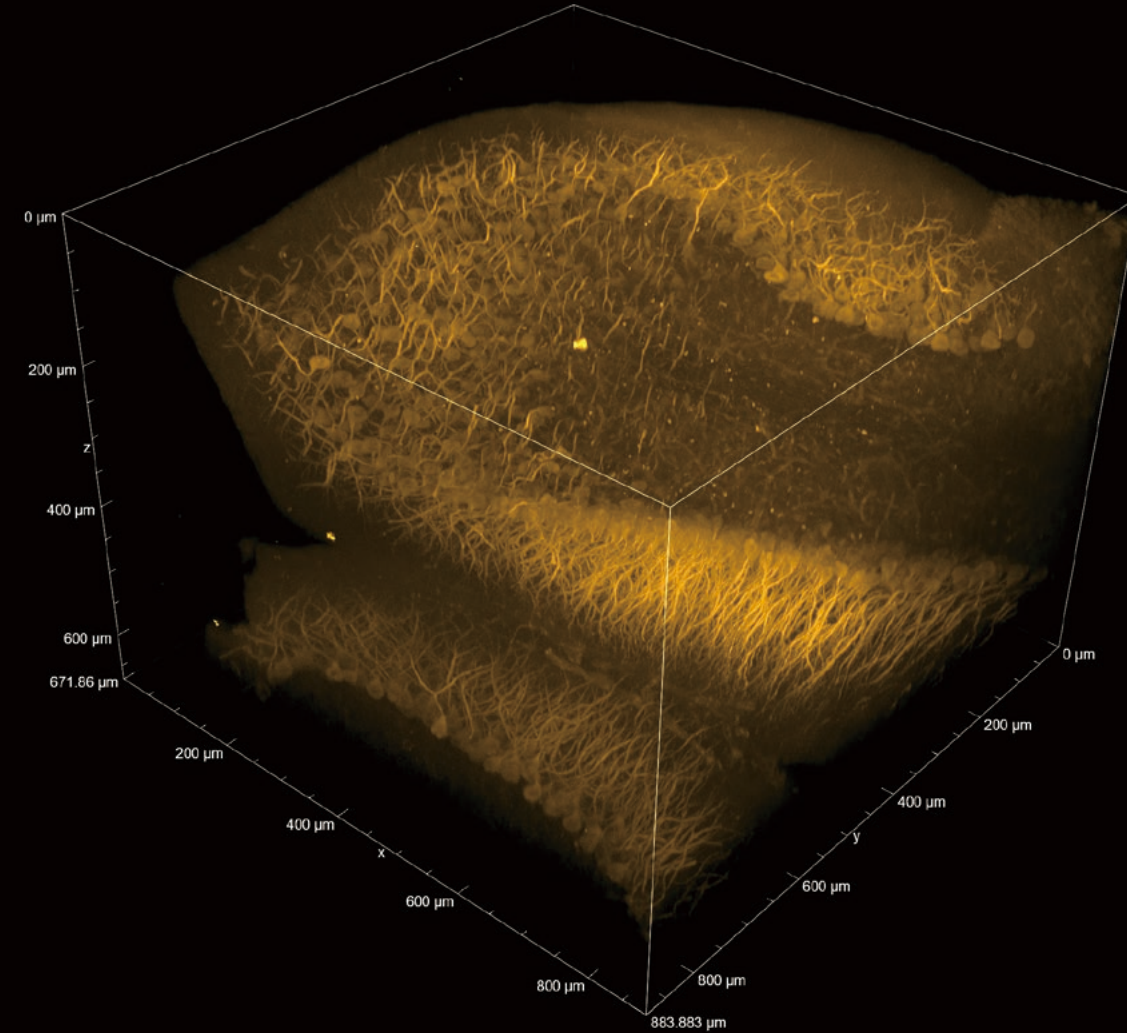

Purkinje neuron in LC3GFP mouse cerebellum

Confocal Imaging



CFI Apochromat LWD Lambda S 20XC WI

A versatile objective for a wide range of applications

Combines high N.A., long working distance and large field of view for imaging thick, live samples. Chromatic aberration correction from visible to IR for multiphoton imaging as well.

- NA: 0.95, WD: 0.95 mm
- Chromatic aberration correction from the visible to IR range
- High-transmittance Nano Crystal Coat
- Correction collar for spherical aberration correction

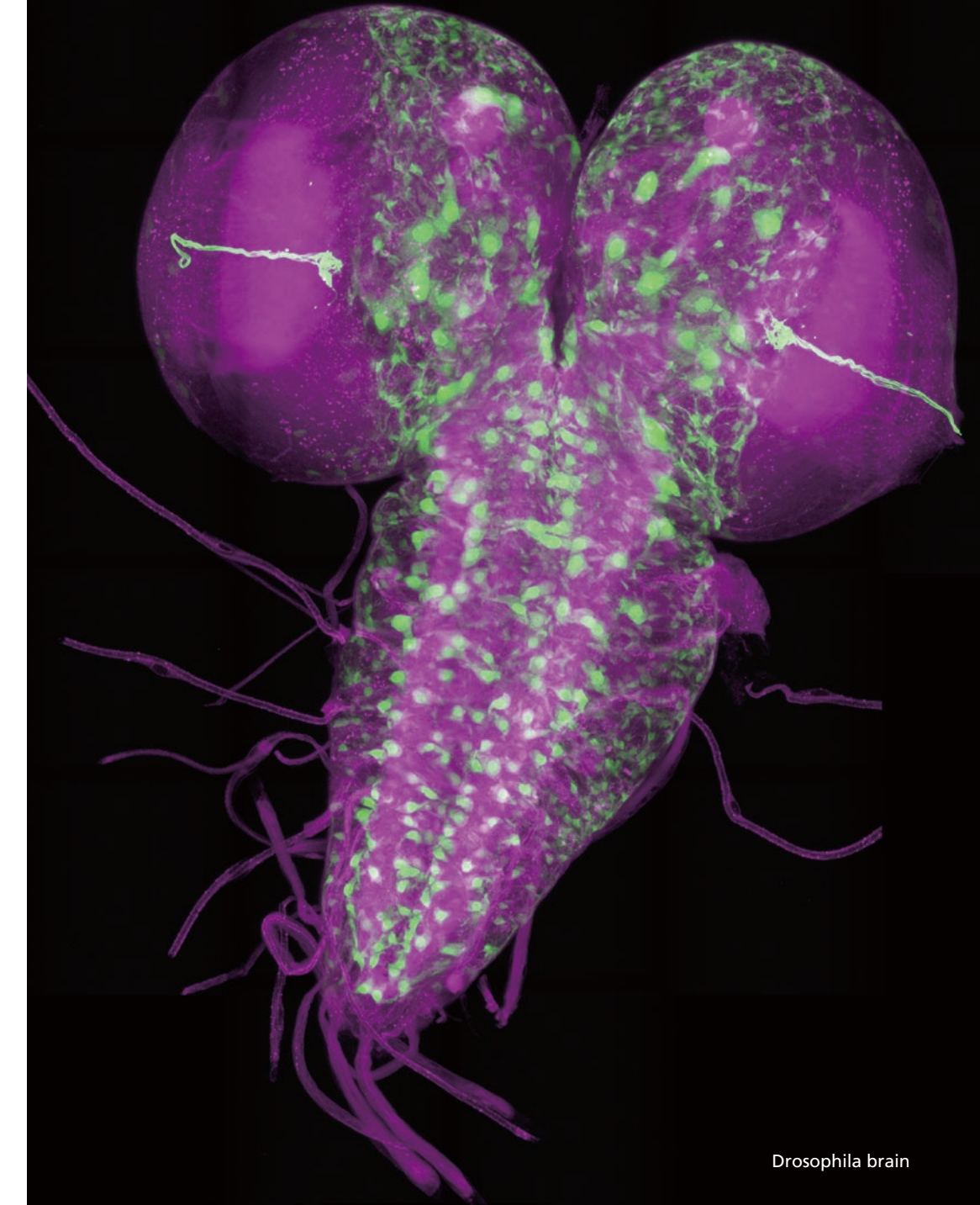

Drosophila brain

Confocal Imaging



CFI Plan Achromat Lambda S 25XC/40XC Sil

High-resolution objectives for observing thick specimens

Silicone oil closely matches the refractive index of live cells, thereby minimizing spherical aberration and providing brighter, higher-resolution images. Unlike water, silicone oil demonstrates minimal evaporation at 37°C, thereby enabling extended, long-term time-lapse imaging experiments.

- NA: 1.05 (25XC)/1.25 (40XC), WD: 0.55 mm (25XC)/0.30 mm (40XC)
- Chromatic aberration correction in the visible range
- High-transmittance Nano Crystal Coat
- Correction collar for spherical aberration correction

Image of mouse embryo courtesy of: Dr. Yoshiteru Kai, Shonan Yume Clinic, Yamashita

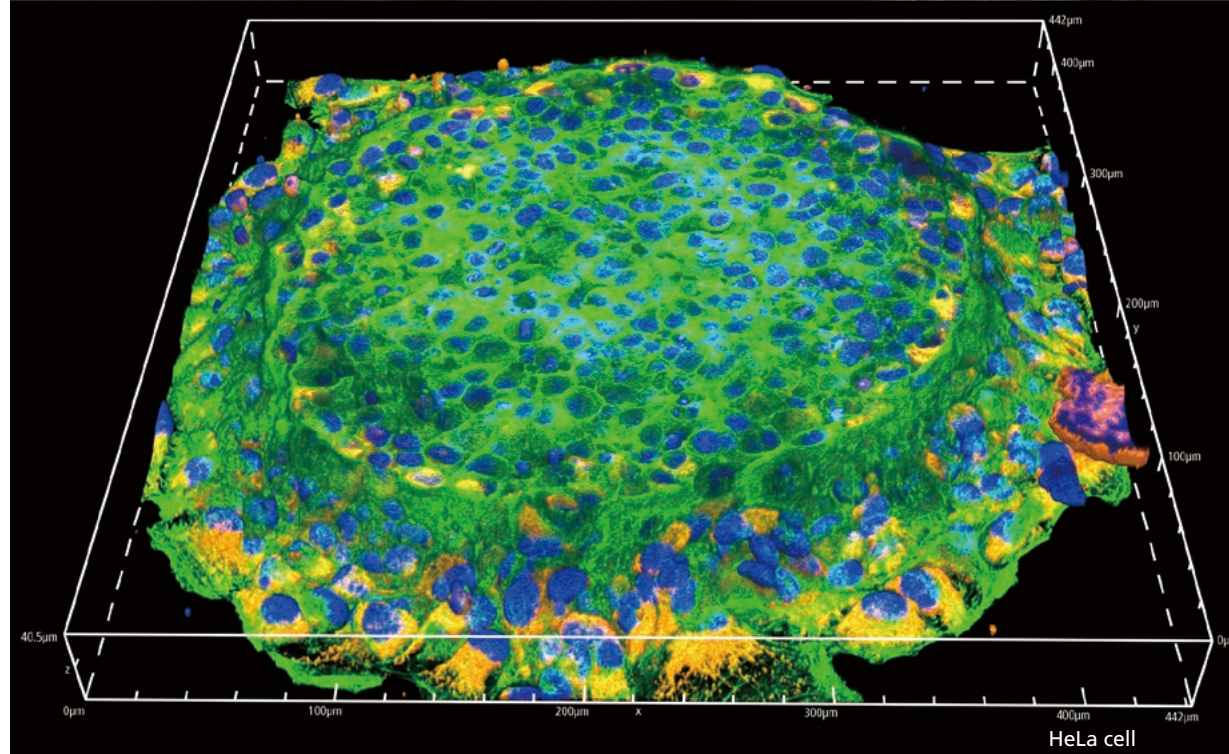
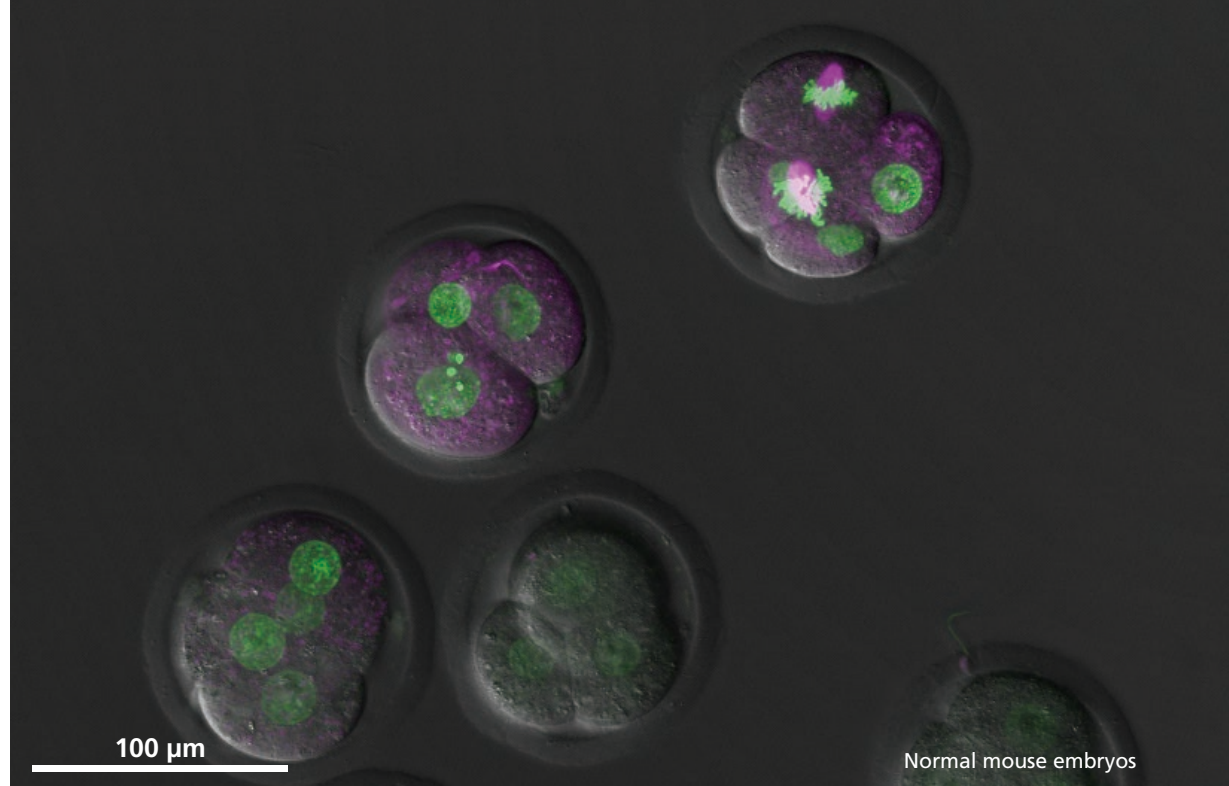

Confocal Imaging



CFI Plan Achromat IR 60XC WI

Incredible resolution and field flatness

This objective provides an NA of 1.27, the highest among 60X water immersion objectives, and achieves incredible field flatness. Corrects for chromatic aberration over a wide wavelength range up to IR, and supports various applications including multicolor live-cell confocal imaging, multiphoton imaging and laser tweezer applications.

- NA: 1.27, WD: 0.17 mm
- Chromatic aberration correction from the visible to IR range
- High-transmittance Nano Crystal Coat
- Correction collar for spherical aberration correction

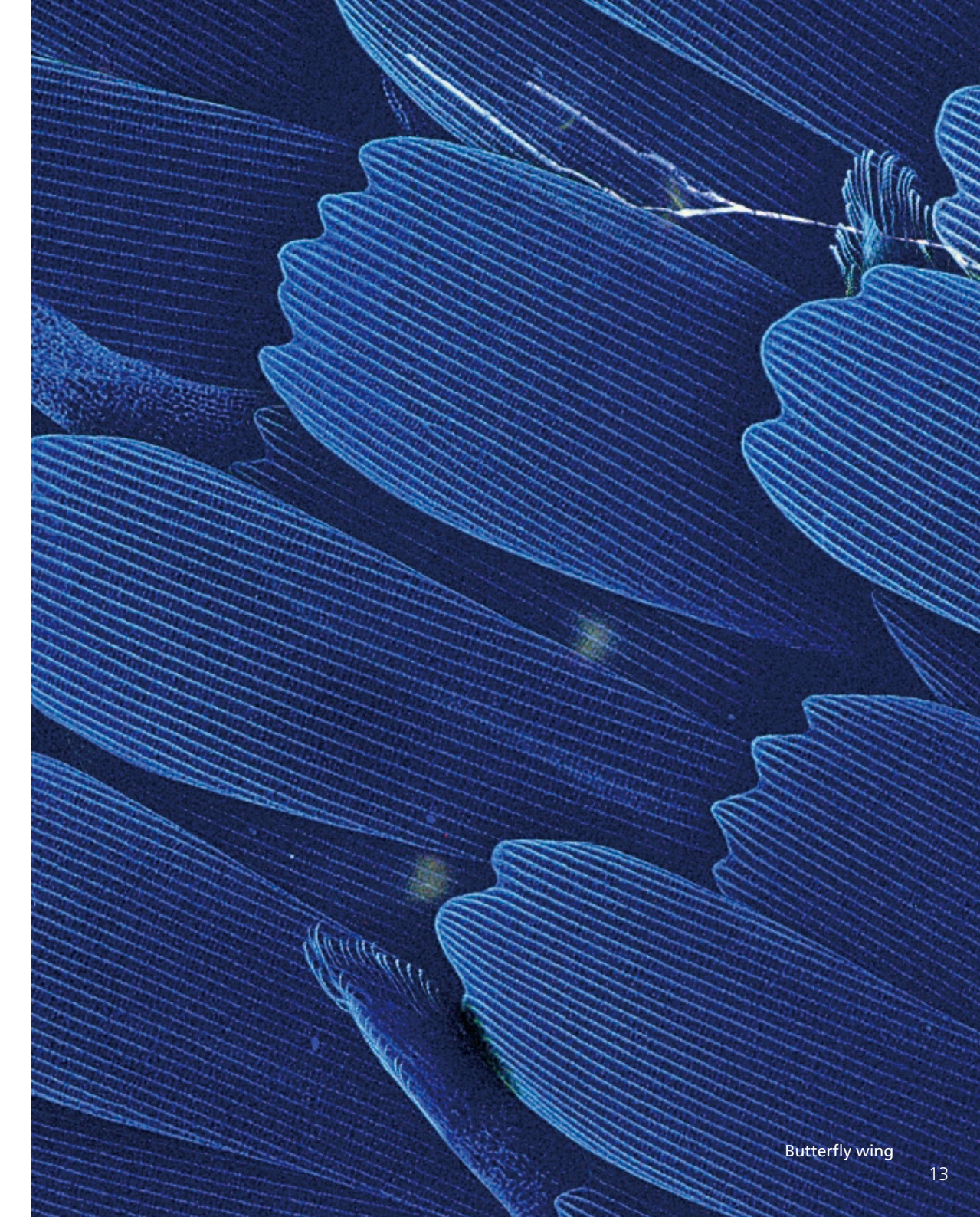

Super-Resolution Imaging



CFI SR HP Plan Apochromat Lambda S 100XC Sil

High-resolution silicone oil immersion objective for imaging live samples

Silicone oil more closely matches the refractive index of live cells compared to water or oil, thereby minimizing spherical aberration issues common to live cell imaging. In addition, the 100XC Sil lens achieves exceptional resolving power even at greater depths, making it well-suited for super-resolution imaging of thicker specimen.

- NA: 1.35, WD: 0.30 mm
- Chromatic aberration correction in the visible range
- High-transmittance Nano Crystal Coat
- Correction collar for spherical aberration correction

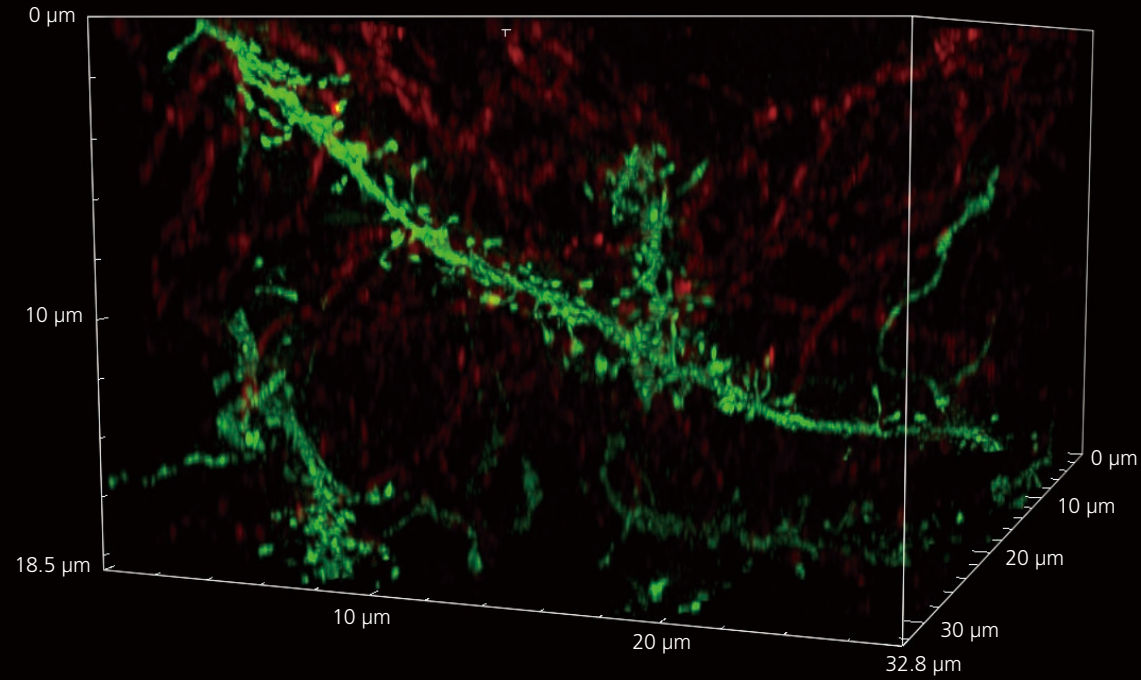

Dendrites

Super-Resolution Imaging



Auto Correction Collar

Quick and accurate spherical aberration correction

Achieving the highest quality point spread function is critical for super-resolution imaging. The ACC quickly moves lens elements in the objective to an optimal position based on the acquired point spread function to minimize spherical aberration.

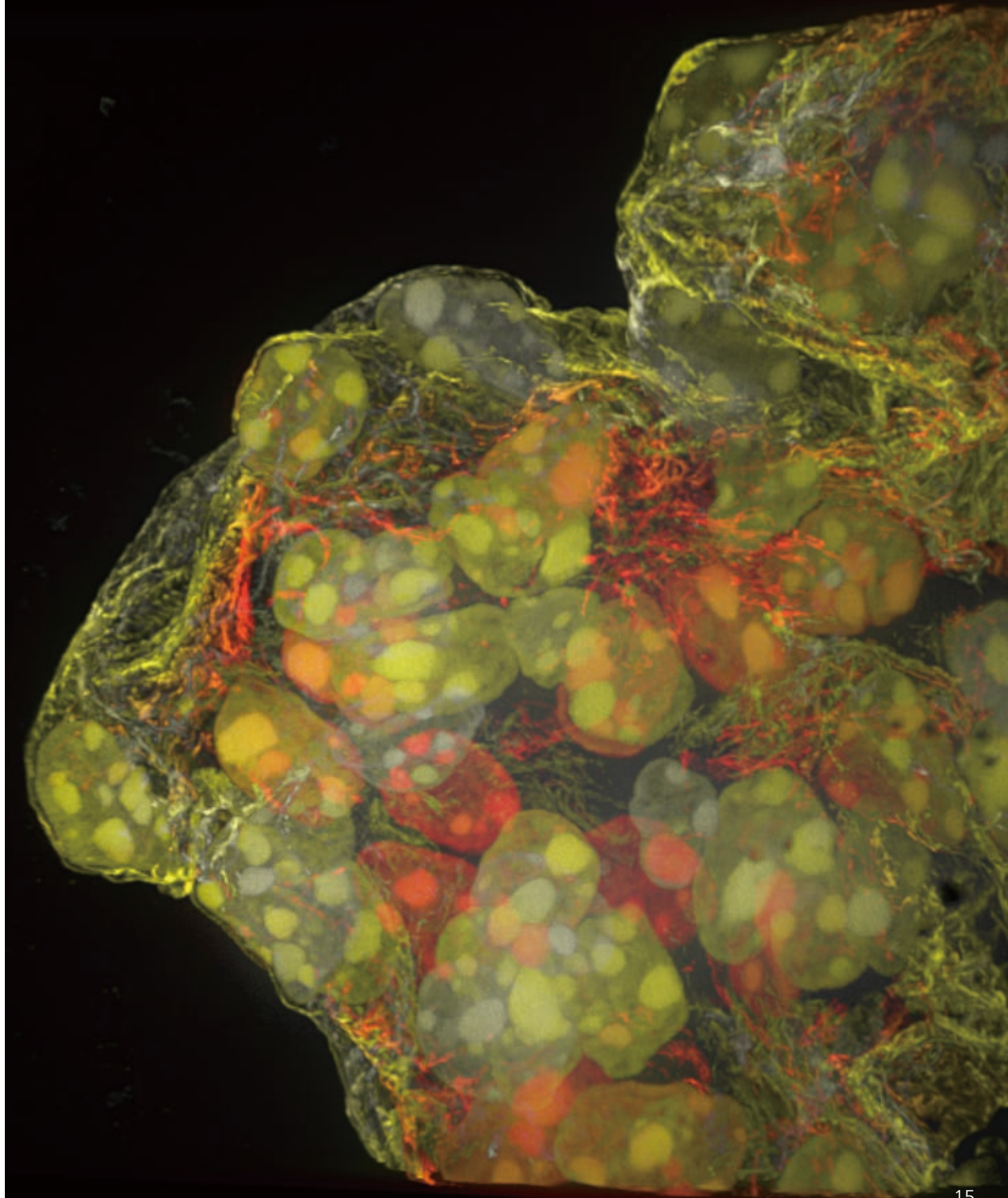

High-Content Imaging



CFI S Plan Fluor LWD ADM 20XC

High NA and long WD objective designed for HC applications

This objective is compatible with thick plastic-bottom dishes and well-plates, and enables high-resolution phase-contrast and fluorescence observations. Its large FOV improves throughput of high-content applications.

- NA: 0.70, WD: 2.30-1.30 mm
- Chromatic aberration correction in the visible range
- Correction collar for spherical aberration correction

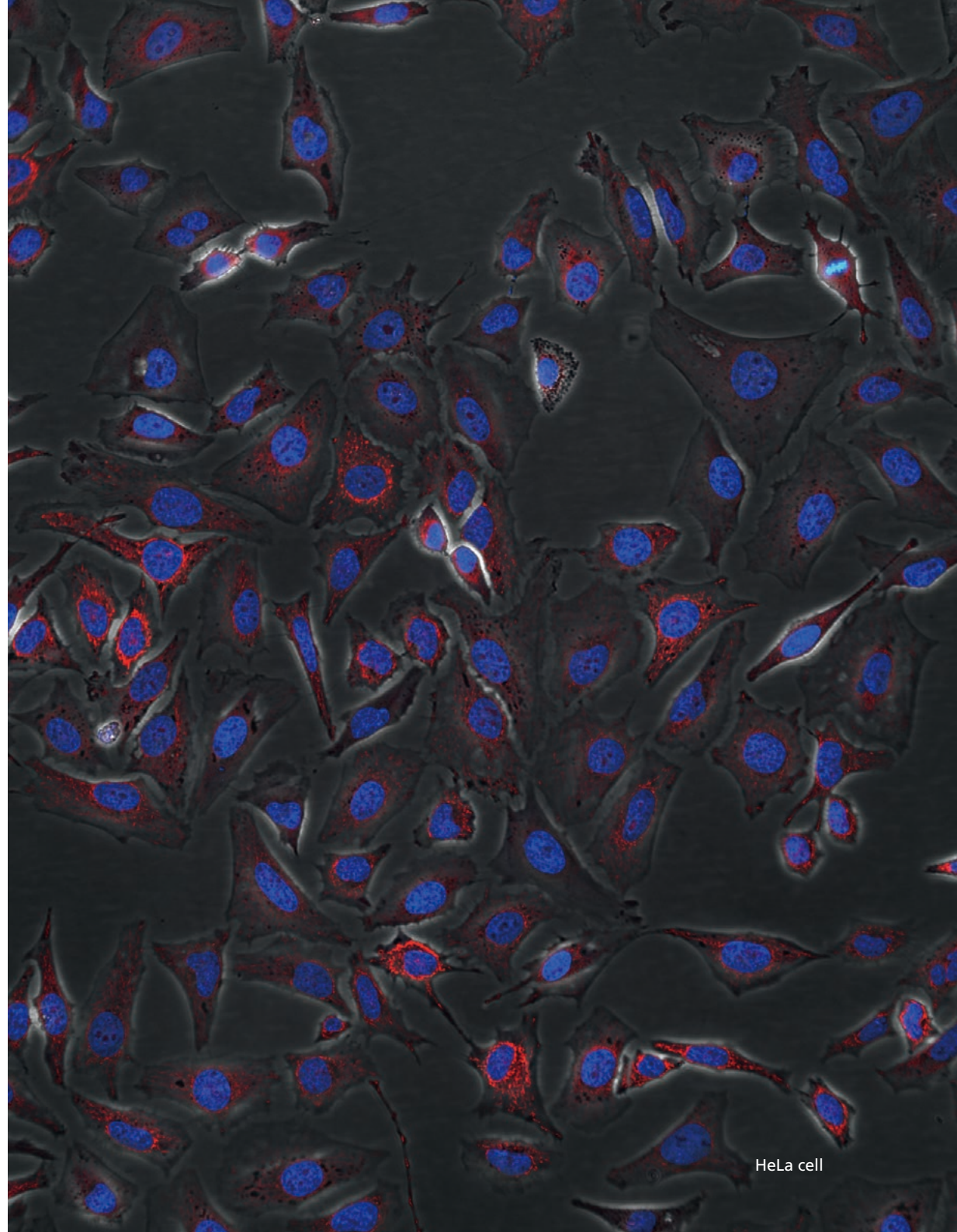

HeLa cell

Pathological Examination



CFI Plan Apochromat Lambda D 40XC

Large field-of-view imaging with uniform brightness

This objective achieves uniform brightness up to the edge of the field of view, chromatic aberration correction from 405 nm upward, and improved resolution. The 25 mm field of view allows you to capture images of a large area of the sample, improving throughput.

- NA: 0.95, WD: 0.21 mm
- Chromatic aberration correction from the visible to near IR range
- High-transmittance Nano Crystal Coat
- Correction collar for spherical aberration correction

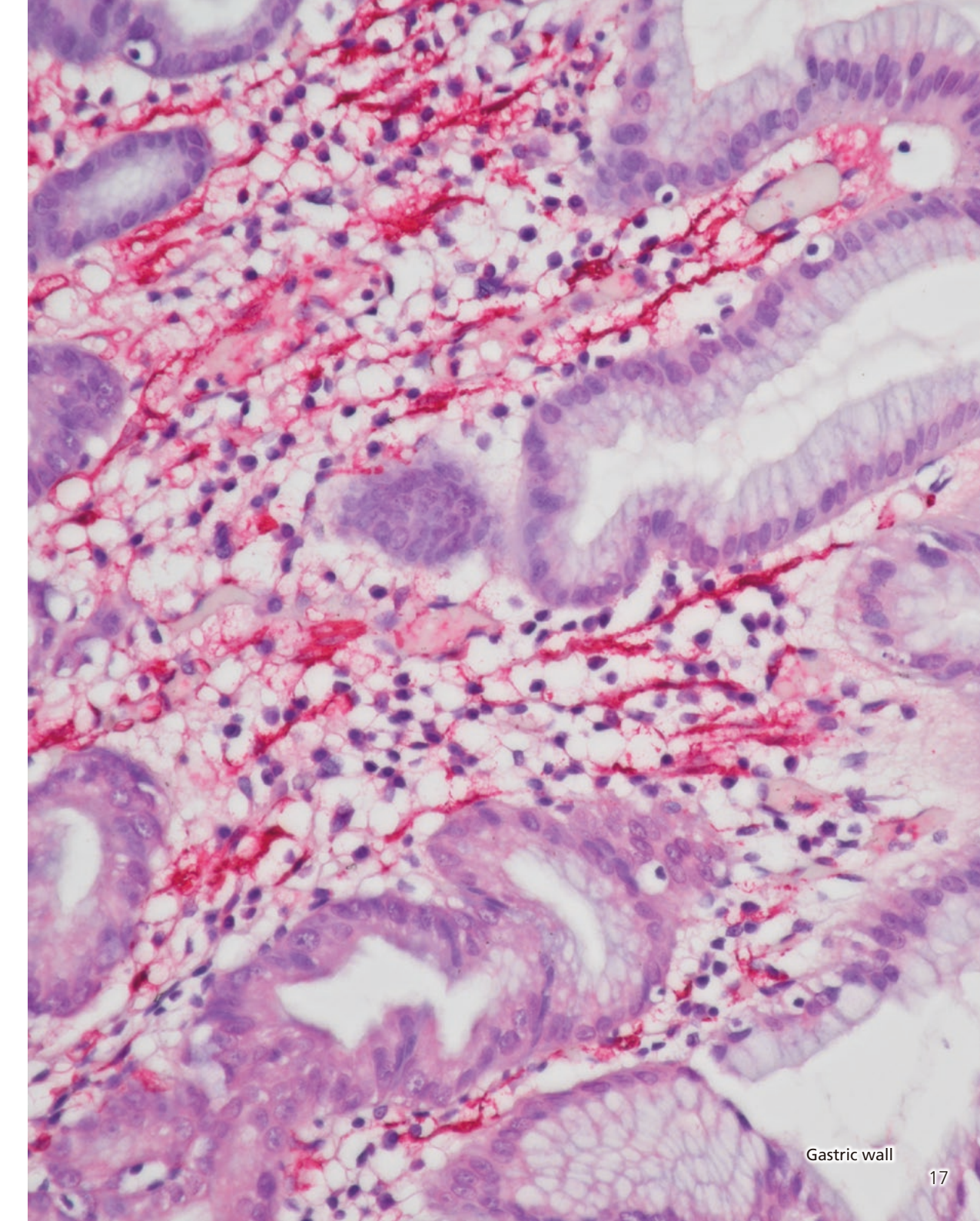

Gastric wall

Image courtesy of: Nichirei Biosciences Inc.

A tool for finding the right objective

Nikon's online Objective Selector tool enables you to quickly and easily find the right objective for your application. Refine your search based on application, technique, objective class, immersion type, etc. Specifications for multiple objectives can be displayed in a single window for easy comparison.

<https://www.microscope.healthcare.nikon.com/selectors/objectives>

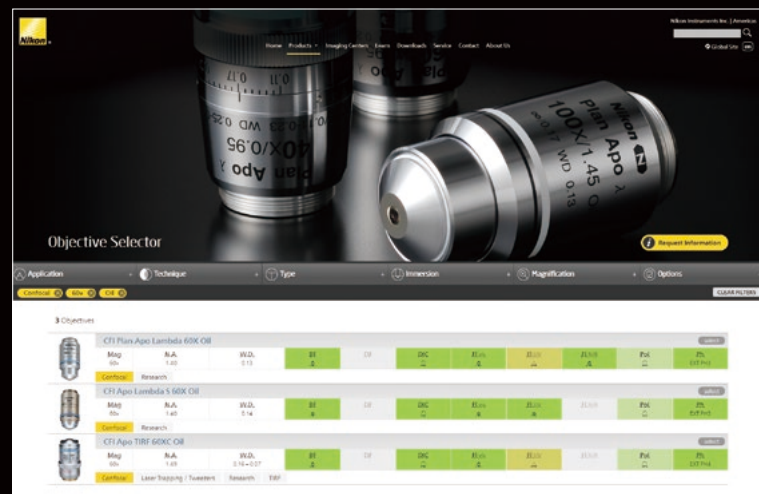

OBJECTIVE SELECTOR



For OEM and DIY

With over 100 years of experience in developing optical technology, Nikon offers a wide range of components that can fulfill almost any optical requirement.

Nikon develops products to the highest standards, from design to manufacture, to ensure we meet the needs of a wide variety of customers.

For detailed specifications including dimensions and transmission information, please refer to the following website.

<https://www.microscope.healthcare.nikon.com/products/oem>

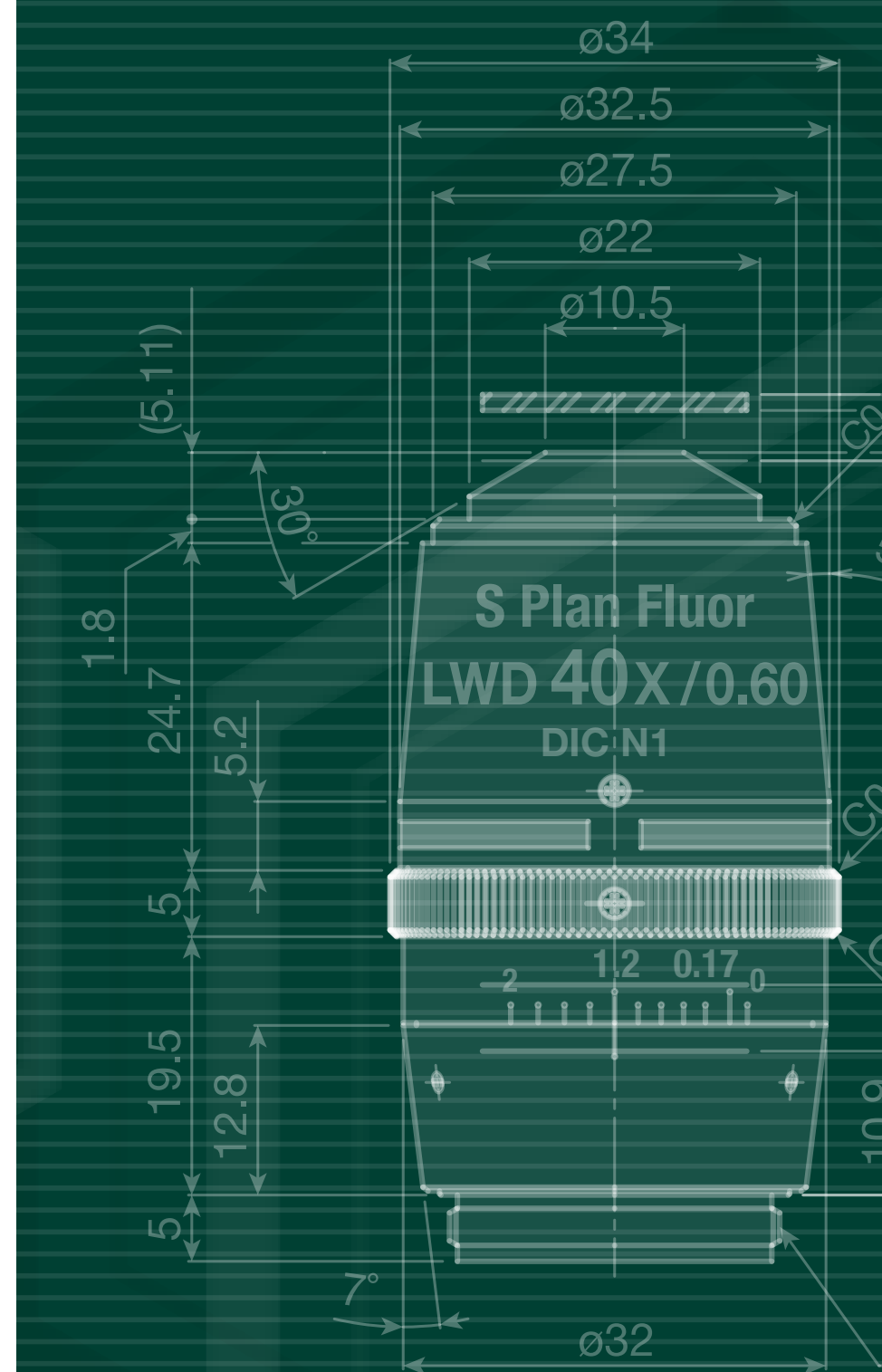

As individual as you

Nikon offers a broad portfolio of objectives to meet your individual application needs. Explore some of the different objective series in the following pages.



CFI Plan Apochromat Lambda D series

Outstanding image flatness and high resolution provide uniform image quality up to the edge of a large field of view of 25 mm, improving efficiency in image tiling and high content screening. Chromatic aberration has been corrected over a wide wavelength range from 405 nm to 850 nm, enabling highly accurate multicolor imaging.



CFI Plan Apochromat Lambda D 2X, 4X, 10X, 20X, 40XC, 60X Oil and 100X Oil

Silicone immersion objectives

Silicone oil closely matches the refractive index (RI) of living cells and tissues, allowing deep observations with minimal optical aberrations. Silicone immersion objectives enable clear observation with a high signal-to-noise ratio deep into living tissue, and facilitate ease of observation with their large fields of view, high resolution, and evaporation-resistant oil.



CFI Plan Apochromat Lambda S 25XC Sil, CFI Plan Apochromat Lambda S 40XC Sil, CFI Plan Apochromat Lambda S 60XC Sil

Use	Model	NA	W.D. (mm)	Cover glass thickness	Spring loaded	Brightfield	Darkfield	DIC	Phase contrast	Polarizing	Fluorescence			Ti2-E PFS	
											UV	Visible light	NIR		
Brightfield (CFI Plan Apo)	Lambda D 2X	0.10	8.50	0/0.17		☉					☉ CF	☉	☉	●	
	Lambda D 4X	0.20	20.00	0/0.17		☉					☉	☉	☉	●	
	Lambda D 10X	0.45	4.00	0.17		☉	△	☉		●	☉	☉	☉	●	
	Lambda D 20X	0.80	0.80	0.17	✓	☉	●	☉		●	☉	☉	☉	●	
	Lambda D 40XC	0.95	0.21	0.11-0.23	✓	☉	●	☉		●	☉ CF	☉	☉	●	
	Lambda D 60X Oil	1.42	0.15	0.17	✓	☉		☉	EXT PH3-60x	●	☉	☉	☉	●	
	Lambda D 100X Oil	1.45	0.13	0.17	✓	☉		☉	EXT PH4-100x*	●	☉	☉	☉	●	
	Lambda S 25XC Sil	1.05	0.55	0.11-0.23		☉	●	☉			●	☉	☉	●	
	Lambda S 40XC Sil	1.25	0.30	0.13-0.21 (23°C) 0.15-0.23 (37°C)		☉	●	☉			●	☉	☉	●	
	Lambda S 60XC Sil	1.30	0.30	0.15-0.19		☉		☉			●	☉	☉	●	
	IR 60XC WI	1.27	0.18-0.16	0.15-0.19		☉		☉		EXT PH3-60x	○	●	☉	☉	●
	NCG 100X Oil	1.40	0.16	0	✓	☉		☉			○	●	☉	●	

* An optical path length difference correction block is required.

Glossary

C: with correction collar
Oil: oil immersion
WI: water immersion
W: water dipping
Mi: multi immersion
Glyc: glycerin immersion
Sil: silicone oil immersion

Cover glass thickness

— : can be used without cover glass
0: use without cover glass

Darkfield

Possible with the following
△ : universal condenser (dry) and darkfield ring
○ : above and darkfield condenser (dry)
● : darkfield condenser (oil)

Phase rings

PHL, PH1, PH2, PH3: condenser cassette modules.
EXT PH3, EXT PH4: external phase contrast modules for Ti2-E.

Fluorescence (UV)

● : possible with visible light that has a longer wavelength than the excitation light used for DAPI
○ : suitable
☉ : recommended for best results
340: high transmittance with an ultraviolet wavelength range of down to 340 nm
CF: confocal imaging is possible at 488 nm and above

Brightfield/DIC/Polarizing/Fluorescence (visible light)

● : possible but not recommended
○ : suitable
☉ : recommended for best results

Ti2-E PFS

● : compatible with PFS

CFI Plan Apochromat VC

With its high degree of chromatic aberration correction and exceptional resolving power, the CFI Plan Apochromat VC 60XC WI is the perfect choice for multi-color fluorescence imaging as well as brightfield and DIC applications. In particular, axial chromatic aberration has been corrected in the short wavelength range, making this objective highly effective for confocal applications.



CFI Plan Apochromat VC 60XC WI

CFI SR series/CFI HP series/CFI SR HP series

Strict adjustment and inspection minimize the SR objective's asymmetric aberration, optimizing it for super-resolution microscopy. The HP objective has improved axial chromatic aberration correction and is compatible with the high-power lasers required for the fast blinks of fluorophores under super-resolution microscopy. The SR HP objective offers both excellent optical performance and high durability against high power laser excitation. AC objectives support the Auto Correction function of the Ti2-E inverted microscope.



CFI SR Plan Apochromat IR 60XC WI, CFI HP Plan Apochromat VC 100X Oil, CFI SR HP Apochromat TIRF 100XC Oil and CFI SR HP Plan Apochromat Lambda S 100XC Sil

Use	Model	NA	W.D. (mm)	Cover glass thickness	Spring loaded	Brightfield	Darkfield	DIC	Phase contrast	Polarizing	Fluorescence			Ti2-E PFS
											UV	Visible light	NR	
Brightfield (CFI Plan Apo)	VC 60XC WI	1.20	0.31-0.28	0.15-0.18	✓	⊙	○	○	EXT PH3-60X	○	⊙	○	○	●
Super-resolution (CFI SR Plan Apo)	IR 60XC WI	1.27	0.18-0.16	0.15-0.19		⊙	○	○	EXT PH3-60X	○	○	○	○	●
	IR 60XAC WI	1.27	0.18-0.16	0.15-0.19		⊙	○	○	EXT PH3-60X	○	○	○	○	●
Super-resolution (CFI HP Plan Apo)	VC 100X Oil	1.40	0.13	0.17	✓	⊙	○	○	EXT PH3-100X	○	●	○	○	●
Super-resolution (CFI SR HP Plan Apo)	Lambda S 100XC Sil	1.35	0.31-0.29 (23°C) 0.30-0.28 (37°C)	0.15-0.19		⊙	○	○		○	○	○	○	●
	TIRF 100XC Oil	1.49	0.16-0.10 (23°C) 0.15-0.09 (37°C)	0.13-0.19 (23°C) 0.14-0.20 (37°C)		⊙	○	○	EXT PH4-100X	○	●	○	○	●
Super-resolution (CFI SR HP Apo)	TIRF 100XAC Oil	1.49	0.16-0.10 (23°C) 0.15-0.09 (37°C)	0.13-0.19 (23°C) 0.14-0.20 (37°C)		⊙	○	○	EXT PH4-100X	○	●	○	○	●

CFI Apochromat Lambda S series

These high-numerical-aperture (NA) objectives provide chromatic aberration correction over wavelengths ranging from violet to near-infrared and are ideal for multicolor confocal imaging. The LWD Lambda S 20XC WI lens has a chromatic aberration correction range up to infrared. The transmittance of these lenses is enhanced over a wide wavelength range by utilizing Nano Crystal Coat technology.



CFI Apochromat Lambda S 40XC WI and CFI Apochromat LWD Lambda S 20XC WI/40XC WI

CFI Apochromat TIRF series

These objectives boast an unprecedented NA of 1.49 (using a standard coverslip and immersion oil), the highest resolution among Nikon objectives. Correction collars enable optimization of point spread functions for varying imaging temperatures, correcting spherical aberration when imaging at 23 and 37 degrees Celsius.



CFI Apochromat TIRF 60XC Oil and 100XC Oil

Multiphoton confocal objectives

These objectives are optimized for deep tissue imaging using a multiphoton confocal microscope, thanks to their ability to correct chromatic aberration up to near-IR range. They provide both long WD and high NA, as well as high transmittance. The Glyc models have a correction collar for the refraction index of immersion liquids, and are compatible with various tissue clearing reagents that are used in neuroscience research.



CFI Plan Apochromat 10XC Glyc, CF190 20XC Glyc, CF175 Apochromat LWD 20XC W and 25XC W 1300

Use	Model	NA	W.D. (mm)	Cover glass thickness	Spring loaded	Brightfield	Darkfield	DIC	Phase contrast	Polarizing	Fluorescence			Ti2-E PFS
											UV	Visible light	NIR	
Confocal (CFI Apo)	LWD Lambda S 20XC WI	0.95	0.99-0.90	0.11-0.23		⊙	●	○		○	○	○	○	●
	LWD Lambda S 40XC WI	1.15	0.61-0.59	0.15-0.19		⊙	●	○	EXT PH3-40X	○	⊙	○	○	●
	Lambda S 40XC WI	1.25	0.20-0.16	0.15-0.19	✓	⊙	○	○	EXT PH3-40X	○	⊙	○	○	●
Evanescent (CFI Apo)	TIRF 60XC Oil	1.49	0.16-0.10 (23°C) 0.13-0.07 (37°C)	0.13-0.19 (23°C) 0.15-0.21 (37°C)		⊙	○	○	EXT PH4-60X	○	●	○	○	●
	TIRF 100XC Oil	1.49	0.16-0.10 (23°C) 0.15-0.09 (37°C)	0.13-0.19 (23°C) 0.14-0.20 (37°C)		○	○	○	EXT PH4-100X	○	●	○	○	●
Multiphoton confocal (CFI Plan Apo)	10XC Glyc	0.50	Upright: 5.50 Inverted: 2.00	0-0.17		⊙	○●					○	○	
Multiphoton confocal (CFI90)	20XC Glyc*	1.00	8.20	0		●***								○
	LWD 20XC W**	1.00	2.8	0-0.17		○						●	○	○
Multiphoton confocal (CFI75 Apo)	25XC W*	1.10	2.00	0		○	●	○****		○	○	○	○	○
	25XC W 1300*	1.10	2.00	0		○	●	○****		○	○	○	○	○

* Dedicated for FN1 and Ni-E focusing nosepiece type
 ** Dedicated for AX R MP multiphoton confocal system
 *** Can only be used as a finder (chromatic aberration is corrected above 588 nm)
 **** Also compatible with near-infrared DIC

CFI Plan Fluor series

Featuring a high transmission rate, especially in the ultraviolet wavelength, and flatness of field, this series is designed for fluorescence observation and imaging. These objectives can function as multi-purpose objectives for brightfield, fluorescence, simple polarizing, and DIC observations.



CFI Plan Fluor 4X, 10X, 20X, 40X, 60XC and 100X Oil



CFI Plan Fluor DLL 10X, 20X, 40X and 100X Oil

CFI Super Fluor series

This CFI Super Fluor series ensures an extra-high transmission rate of ultraviolet wavelengths down to 340nm for fluorochromes like indo-1 and fura-2. Also, these objectives have improved S/N ratios for short wavelengths and have high NA, making the fluorescence images they produce significantly sharper and brighter.



CFI Super Fluor 10X, 20X, 40XC and 40X Oil

Use	Model	NA	W.D. (mm)	Cover glass thickness	Spring loaded	Brightfield	Darkfield	DIC	Phase contrast	Polarizing	Fluorescence		Ti2-E PFS
											UV	Visible light	
Brightfield (CFI Plan Fluor)	4X	0.13	17.20	—		○				●	○	○	●
	10X	0.30	16.00	0.17		○	△	○		○	○	○	●
	20X	0.50	2.10	0.17		○	●	○		○	○	○	●
	20XC MI	0.75	0.51-0.35 (oil) 0.51-0.34 (glycerin) 0.49-0.33 (water)	0-0.17	✓	○	●	○		○	○	○	●
	40X	0.75	0.66	0.17	✓	○	●	○		○	○	○	●
	40X Oil	1.30	0.24	0.17	✓	○	●	○	EXT PH3-40X	○	○	○	●
	60XC	0.85	0.40-0.31	0.11-0.23	✓	○	●	○		○	○	○	●
	60XS Oil	0.50-1.25	0.22	0.17	✓	○	●	○	EXT PH3-60X	○	○	○	●
Phase contrast (CFI Plan Fluor)	100X Oil	1.30	0.16	0.17	✓	○	●	○		○	○	○	●
	100XS Oil	0.50-1.30	0.16	0.17	✓	○	●	○		○	○	○	●
	DL 4XF	0.13	16.50	1.20		○			○ PHL	○	○	○	●
	DLL 10X	0.30	16.00	0.17		○	△		○ PH1	○	○	○	●
	DL 10XF	0.30	15.20	1.20		○	△		○ PH1	○	○	○	●
	DLL 20X	0.50	2.10	0.17		○	●		○ PH1	○	○	○	●
	DLL 40X	0.75	0.66	0.17	✓	○	●		○ PH2	○	○	○	●
	DLL 100X Oil	1.30	0.16	0.17	✓	○	●		○ PH3	○	○	○	●
Apodized phase contrast (CFI Plan Fluor)	DM 40X	0.75	0.66	0.17	✓	○	●		○ PH2	○	○	○	●
	BM 40X	0.75	0.66	0.17	✓	○	●		○ PH2	○	○	○	●
	ADH 100X Oil	1.30	0.16	0.17	✓	○	●		○ PH3	○	○	○	●
Brightfield (CFI Super Fluor)	4X	0.20	15.50	—		○				●	○	○	●
	10X	0.50	1.10	0.17	✓	○	●	○		●	○	○	●
	20X	0.75	1.00	0.17	✓	○	●	○		●	○	○	●
	40XC	0.90	0.34-0.26	0.11-0.23	✓	○	●	○		●	○	○	●
	40X Oil	1.30	0.19	0.17	✓	○	●	○		●	○	○	●
	100XS Oil	0.50-1.30	0.20	0.17	✓	○	●	○		●	○	○	●

CFI S Plan Fluor series

The broadband multilayer coating realizes high transmittance from ultraviolet to near-infrared wavelengths, with superior chromatic correction. The correction collar allows these objectives to be used with a diverse range of culture vessels and specimen thicknesses. High-quality images with no aberrations can be obtained under a broad range of illumination techniques.



CFI S Plan Fluor LWD 20XC and LWD ADM 20XC



CFI S Plan Fluor ELWD 20XC, 40XC and 60XC

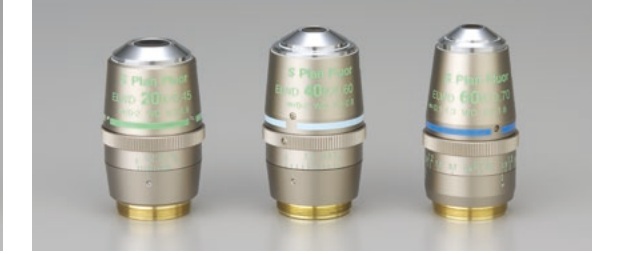

CFI S Plan Fluor ELWD ADM 20XC, 40XC and ADL 60XC

Nikon Advanced Modulation Contrast (NAMC) series

Nikon has developed dedicated objectives for advanced modulation contrast. Colorless and transparent samples can be observed in high relief with a plastic dish, which is not possible in DIC observation. The direction of contrast can be matched to S Plan Fluor ELWD NAMC objectives, thereby allowing optimal contrast selection for techniques like microinjection and ICSI.



CFI S Plan Fluor ELWD NAMC 20XC and 40XC



CFI NAMC 10XF, CFI LWD NAMC 20XF and 40XC

Use	Model	NA	W.D. (mm)	Cover glass thickness	Spring loaded	Brightfield	Darkfield	DIC	Phase contrast	Polarizing	Fluorescence		Ti2-E PFS
											UV	Visible light	
Brightfield (CFI S Plan Fluor)	LWD 20XC	0.70	2.30-1.30	0-1.80		○	●	○		○	○	○	●
	ELWD 20XC	0.45	8.20-6.90	0-2.00		○	●	○		○	○	○	●
	ELWD 40XC	0.60	3.60-2.80	0-2.00		○	●	○		○	○	○	●
	ELWD 60XC	0.70	2.60-1.80	0.10-1.30		○	●	○		○	○	○	●
Apodized phase contrast (CFI S Plan Fluor)	LWD ADM 20XC	0.70	2.30-1.30	0-1.80		○	●		○ PH2	○	○	○	●
	ELWD ADM 20XC	0.45	8.20-6.90	0-2.00		○	●		○ PH1	○	○	○	●
	ELWD ADM 40XC	0.60	3.60-2.80	0-2.00		○	●		○ PH2	○	○	○	●
	ELWD ADL 60XC	0.70	2.60-1.80	0.10-1.30		○	●		○ PH2	○	○	○	●
Advanced modulation contrast (CFI S Plan Fluor)	ELWD NAMC 20XC	0.45	8.20-6.90	0-2.00		○				○	○	○	●
	ELWD NAMC 40XC	0.60	3.60-2.80	0-2.00		○				○	○	○	●
Advanced modulation contrast (CFI)	NAMC 10XF	0.25	6.20	1.20		○						○	●
	LWD NAMC 20XF	0.40	3.10	1.20		○						○	●
	LWD NAMC 40XC	0.55	2.70-1.70	0-2.00		○						○	●

CFI Plan Achromat series

CFI Plan Achromat series provides incredible image flatness, with chromatic aberration corrected throughout the entire visible spectrum. These objectives are suitable not only for observation but also for capturing images.



CFI Plan 1X, 2X, 4X, 10X, 20X, 40X and 100X Oil



CFI Plan DL 10X, 20X, 40X and 100X Oil

Water Dipping Series

Sharper tips and broad approach angles provide improved accessibility for manipulator control. Aberrations are corrected even in the infrared range for high-magnification objectives, making them suitable for multi-photon imaging using infrared light.



CFI Plan Fluor 10XW, CFI75 LWD 16XW, CFI Apochromat NIR 40XW/60XW and CFI Plan 100XC W

Use	Model	NA	W.D. (mm)	Cover glass thickness	Spring loaded	Brightfield	Darkfield	DIC	Phase contrast	Polarizing	Fluorescence		Near- infrared DIC
											UV	Visible light	
Brightfield (CFI Plan)	1X	0.04	3.20	—		○				●		●	
	2X	0.06	7.50	—		○				●		●	
	4X	0.10	30.00	—		○				●		○	
	10X	0.25	10.50	—		○	△			●		○	
	20X	0.40	1.20	0.17		○	○●			●		○	
	40X	0.65	0.56	0.17	✓	○	○●			●		○	
	50X Oil	0.90	0.35/0.18	-0.17	✓	○	●			●		○	
	100X Oil	1.25	0.20	0.17	✓	○				●		○	
	NCG 40X	0.65	0.48	0	✓	○	○●			●		○	
	NCG 100X	0.90	1.00	0	✓	○	●			●		○	
Phase contrast (CFI Plan)	DL 10X	0.25	10.50	—		○	△		○ PH1	●		●	
	DL 20X	0.40	1.20	0.17		○	○●		○ PH1	●		●	
	DL 40X	0.65	0.56	0.17	✓	○	○●		○ PH2	●		●	
	DL 100X Oil	1.25	0.20	0.17	✓	○			○ PH3	●		●	
DIC (CFI Plan Fluor)	10X W	0.30	3.50	0		○	△	○		○	○	○	
IR-DIC (CFI Apo)	NIR 40X W	0.80	3.50	0		○	●	○		○	○	○	
	NIR 60X W	1.00	2.80	0		○	●	○		○	○	○	
DIC (CFI Plan)	100XC W	1.10	2.50	0		○	●	○		○	○	○	
DIC (CFI75)	LWD 16X W *	0.80	3.00	0		○	●	○		○	○	○	

* Dedicated for FN1 and Ni-E focusing nosepiece type

CFI Achromat series

This series of objectives provide dramatic correction for chromatic aberration, spherical aberration and coma. Image flatness is significantly improved.

Nikon specifically developed ADL series for phase contrast observations by using its proprietary apodization process to improve the objective's phase ring. Imaging cell division is often impeded by unwanted halos due to the sample thickness. ADL mitigates this effect for clearer observation of mitotic events.



CFI 4X and 10X, CFI LWD 20X, CFI 40X, CFI NCG 60X and CFI 100X Oil



CFI DL 10X, CFI LWD DL 20X, CFI DL 40X and 100X Oil



CFI ADL 10XF, CFI LWD ADL 20XF, 40XF and 40XC

Use	Model	NA	W.D. (mm)	Cover glass thickness	Spring loaded	Brightfield	Darkfield	DIC	Phase contrast	Polarizing	Fluorescence		Ti2-E PFS
											UV	Visible light	
Brightfield (CFI)	4X	0.10	30.00	—		○				●		○	
	10X	0.25	7.00	—		○	△			●		○	
	LWD 20X	0.40	3.90	0.17		○	○●			●		○	
	40X	0.65	0.65	0.17	✓	○	○●			●		○	
	LWD 40XC	0.55	2.70-1.70	0-2.00		○	○●			●		○	
	60X	0.80	0.30	0.17	✓	○	●			●		○	
	NCG 60X	0.80	0.30	0.17	✓	○	○●			●		○	
	100X Oil	1.25	0.23	0.17	✓	○				●		○	
	100XS Oil	0.50-1.25	0.23	0.17	✓	○	○●			●		○	
	Phase contrast (CFI)	DL 10X	0.25	7.00	—		○	△		○ PH1	●		●
LWD DL 20X		0.40	3.90	0.17		○	○●		○ PH1	●		●	
LWD DL 20XF		0.40	3.10	1.20		○			○ PH1	●		●	
DL 40X		0.65	0.65	0.17	✓	○	○●		○ PH2	●		●	
LWD DL 40XC		0.55	2.70-1.70	0-2.00		○	○●		○ PH2	●		●	
DL 100X Oil		1.25	0.23	0.17	✓	○			○ PH3	●		●	
BM 10X		0.25	7.00	0.70		○			○ PH1	●		●	
Apodized phase contrast (CFI)		ADL 10XF	0.25	6.20	1.20		○			○ PH1	●		●
	LWD ADL 20XF	0.40	3.10	1.20		○			○ PH1	●		●	
	LWD ADL 40XF	0.55	2.10	1.20		○			○ PH1	●		●	
	LWD ADL 40XC	0.55	2.70-1.70	0-2.00		○	○●		○ PH2	●		●	

Specifications and equipment are subject to change without any notice or obligation on the part of the manufacturer. July 2024
© 2024 NIKON CORPORATION



Optics product page



WARNING

TO ENSURE CORRECT USAGE, READ THE CORRESPONDING MANUALS CAREFULLY BEFORE USING YOUR EQUIPMENT.

Company names and product names appearing in this brochure are their registered trademarks or trademarks.
N.B. Export of the products* in this brochure is controlled under the Japanese Foreign Exchange and Foreign Trade Law. Appropriate export procedure shall be required in case of export from Japan.
*Products: Hardware and its technical information (including software)



NIKON CORPORATION

Head office
1-5-20, Nishi-oi, Shinagawa-ku, Tokyo 140-8601, Japan
<https://www.healthcare.nikon.com/en/>

Manufacturer
471, Nagaodai-cho, Sakae-ku, Yokohama, Kanagawa 244-8533, Japan

Nikon Instruments Inc.

1300 Walt Whitman Road, Melville, N.Y. 11747-3064, U.S.A.
phone: +1-631-547-8500; +1-800-52-NIKON (within the U.S.A. only)
fax: +1-631-547-0299
<https://www.microscope.healthcare.nikon.com/>

Nikon Europe B.V.

Stroombaan 14, 1181 VX Amstelveen, The Netherlands
phone: +31-20-7099-000
https://www.microscope.healthcare.nikon.com/en_EU/

Nikon Precision (Shanghai) Co., Ltd.

CHINA phone: +86-21-6841-2050 fax: +86-21-6841-2060
(Beijing branch) phone: +86-10-5831-2028 fax: +86-10-5831-2026
(Guangzhou branch) phone: +86-20-3882-0550 fax: +86-20-3882-0580
<https://www.nikon-precision.com.cn/>

Nikon Canada Inc.

CANADA phone: +1-905-625-9910 fax: +1-905-602-9953

Nikon France, Succursale de Nikon Europe B.V.

FRANCE phone: +33-1-4516-4516

Nikon Deutschland, Zweigniederlassung der Nikon Europe B.V.

GERMANY phone: +49-211-9414-888

Nikon Italy, Branch of Nikon Europe B.V.

ITALY phone: +39-055-300-9601

Nikon Europe B.V., Amstelveen, Zweigniederlassung Schweiz (Egg/ZH)

SWITZERLAND phone: +41-43-277-2867

Nikon UK, Branch of Nikon Europe B.V.

UNITED KINGDOM phone: +44-208-247-1717

Nikon Österreich, Zweigniederlassung der Nikon Europe B.V.

AUSTRIA phone: +43-1-972-6111

Nikon Singapore Pte. Ltd.

SINGAPORE phone: +65-6559-3651 fax: +65-6559-3668

Nikon Australia Pty Ltd

AUSTRALIA phone: +61-2-8767-6900

Nikon Instruments Korea Co., Ltd.

KOREA phone: +82-2-6288-1900 fax: +82-2-555-4415

Nikon India Private Limited

INDIA phone: +91-124-4688-500