



Fixed Stage Microscope for Electrophysiological Research
ECLIPSE FN1

ECLIPSE FN1

Fixed Stage Microscope for Electrophysiological Research



Shedding New Light On **MICROSCOPY**

ECLIPSE FN1

Fixed Stage Microscope for Electrophysiological Research

State-of-the-art Research Microscope Optimized for Observation and Analysis of *in vivo/in vitro* Nervous Activity

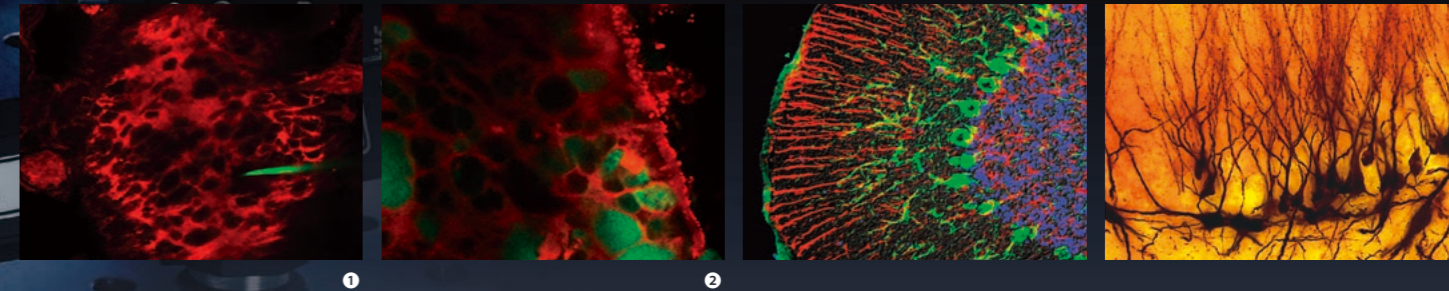

The Eclipse FN1 is a special purpose upright microscope developed to meet the rigorous demands of electrophysiological research.

Never before has an electrophysiological microscope enabled visualization of minute details deep within a specimen with such clarity and contrast. The FN1 has a completely redesigned optical system that includes the world's first water dipping objective with depth-induced aberration correction.

Moreover, in combination with the new multiphoton confocal microscope system A1R MP+, high sensitivity deep in vivo confocal images can be acquired at high speed.



Configuration with Narishige stage

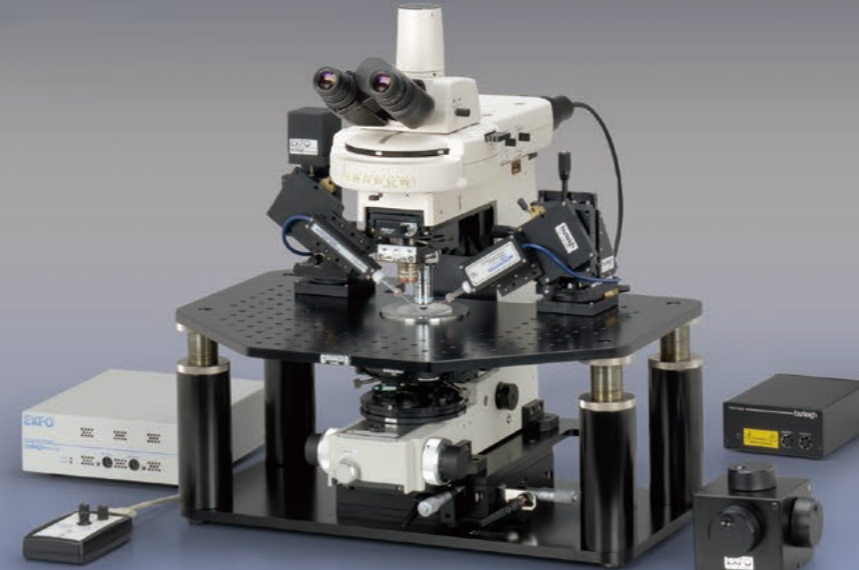

Configuration with EXFO stage



Configuration with Nikon stage



Objective Lenses Allow Imaging of Deeper Areas with Ultimate Clarity

The true one-lens solution: LWD 16X objective

By using a variable magnification double port (optional), the 16X objective allows you to capture images from a low magnification wide field at 5.6X to a high magnification high resolution at 64X with the rear port CCD camera*¹ with the same lens. A wide viewfield of up to 2.0mm can be achieved at 0.35X intermediate magnification, enabling the observation of whole specimens and easy electrode placement. Variable magnification double port varies magnification between three levels (0.35X/2X/4X or 0.35X/1X/4X).

*Magnification of the front port is not variable.

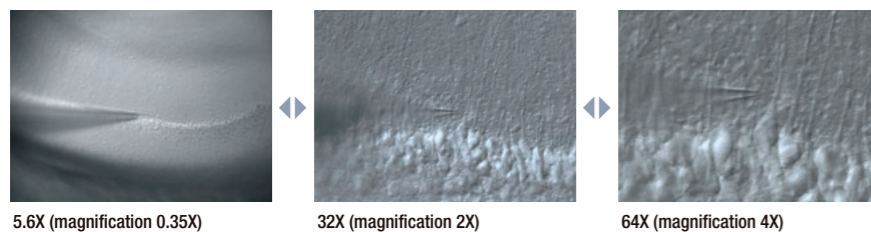

Images courtesy of: Dr. Hiroyoshi Miyakawa, Dr. Shigeo Watanabe, Tokyo University of Pharmacy and Life Science



As the 16X objective has a wide 45° manipulator approach angle and 3.0mm long working distance.

The world's first water dipping objective with depth-induced aberration correction

The CFI Plan 100XC W objective (NA 1.1, W.D. 2.5mm) is the world's first water dipping lens with a correction ring. This ring corrects spherical aberration induced by imaging deep in tissue or by working at physiological temperatures — providing outstanding Z-axis resolution in IR-DIC imaging, as well as a tight point spread function for confocal applications. With excellent IR transmission, this lens is a terrific choice for Multi-Photon imaging.

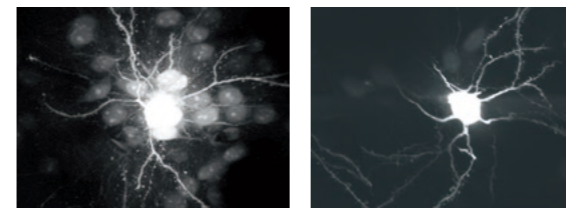

Images courtesy of: Hiroyuki Hakozaiki MS, University of California, San Diego

New objective series — ideal for IR-DIC imaging

Axial chromatic aberration in the visible to near-infrared region (up to 850nm) has been corrected in CFI Apochromat NIR 40X W and 60X W objectives. This enables the user to observe/document minute structures of a thick specimen with ample resolution. In addition, transmittance of every objective is exceptionally high, even in the IR region, thanks to wide-range spectrum anti-reflection coatings.



Easy insertion of microelectrode

The objectives boast a long W.D. of 2.5-3.5mm (2.5mm even at 60X or 100X), taking advantage of the 60mm parfocal distance of the CFI60 optics. Since there is ample space above the specimen, microelectrodes can be easily inserted. The diameters of the objectives are 17% slimmer than previous lenses, and provide broad approach angles up to 45°, facilitating dramatically enhanced access of microelectrodes to the specimen.

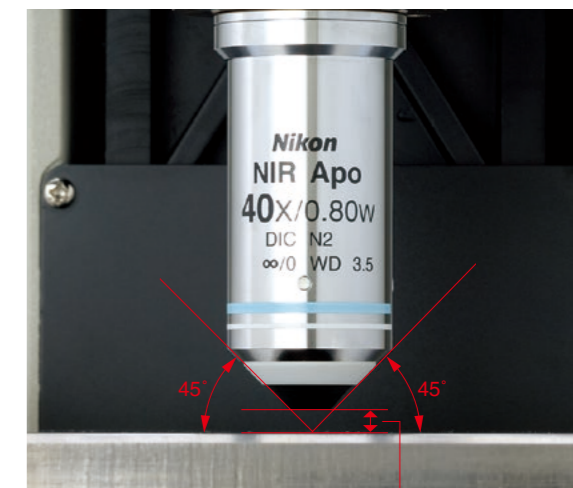

45° approach angle, long working distance



Water dipping objective CFI Plan 100XC W
Water dipping objective CFI75 LWD 16X W

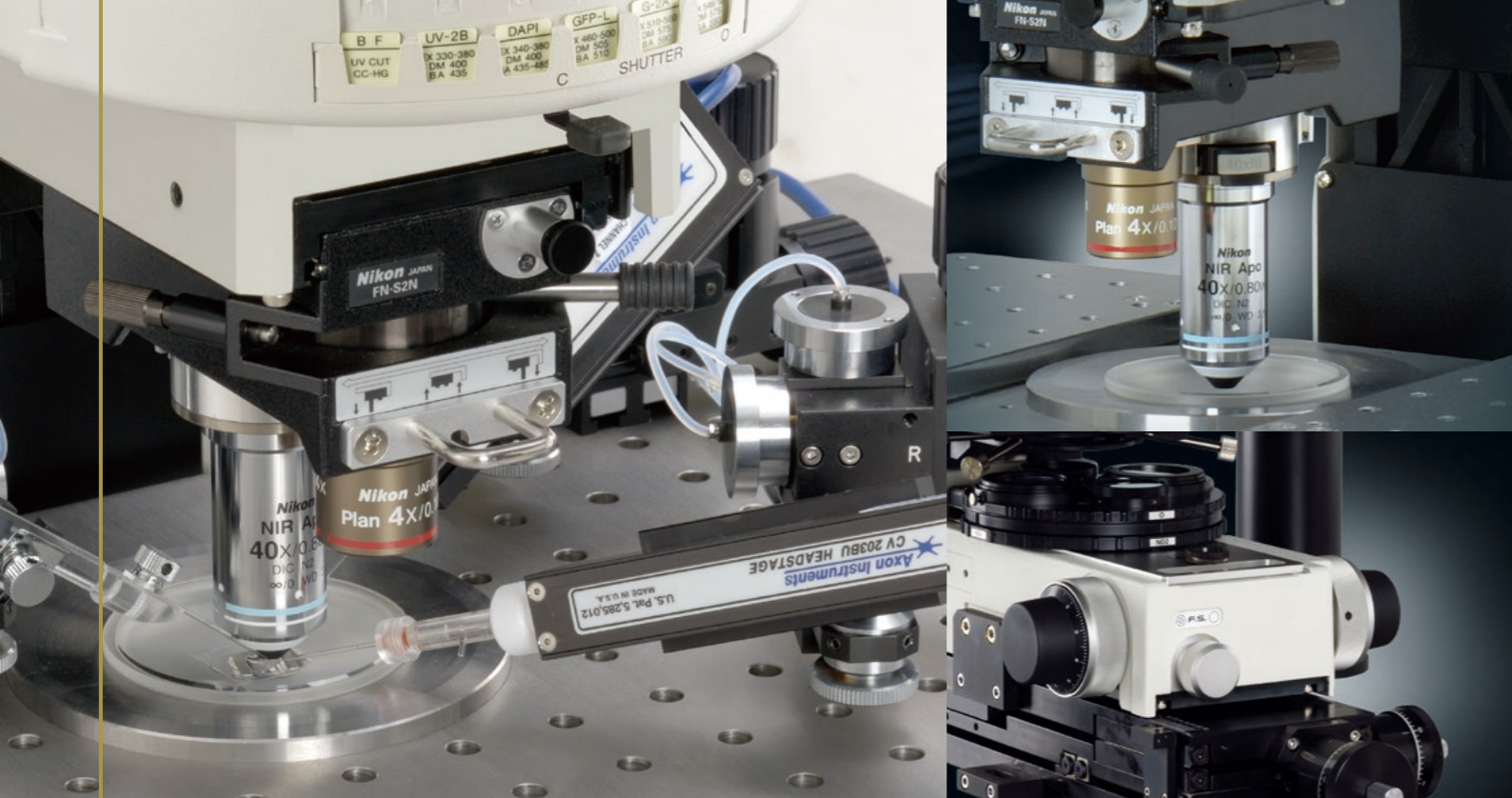

Streamlined Electrophysiological Experiments and Broad Work Space

Smoother objectives changeover

The FN1 comes with a 2-position sliding nosepiece. A high magnification objective can be mounted on either the front or back position.

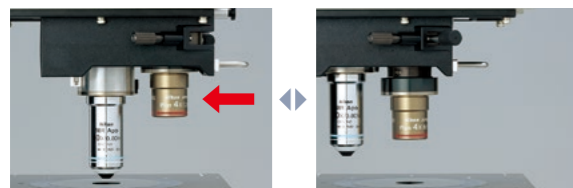

Front/back sliding objective changeover

The objectives can be raised by the lever to prevent collision with the manipulator or the chamber when they are being changed. The retraction distance is 15mm, so even a thick glass dish is protected.

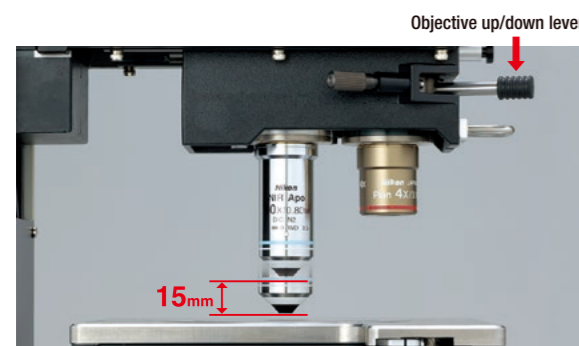

Objective retraction mechanism

Parfocal distance correction and centering mechanism

The parfocal distance of both the front and rear objectives can be finely tuned to achieve perfect parfocality. The front objective has a centering mechanism, which ensures perfect parcentricity, making it simple to find your cell when switching to a higher magnification.



Safe, accurate dipping operation

After the objective has been lowered, it can be further lowered by approximately 1mm by depressing the lens up/down lever to gently dip the lens top into the bath solution. This eliminates the risk of specimen disturbance due to the lowering of the objective deep into the solution.

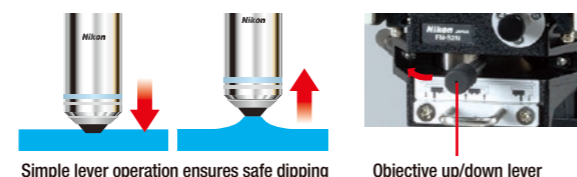

Simple lever operation ensures safe dipping

Objective up/down lever

Simple wavelength/illumination switchover

Alternating wavelength from visible to IR (infrared), or illumination technique from DIC and Oblique Light is carried out simply by rotating the wavelength selection and illumination selection turrets. Oblique illumination provides high contrast with deeper shadows by providing incident illumination at shallow angles.

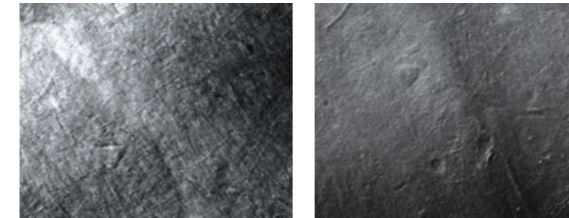

Observed under oblique illumination

Observed under IR-DIC illumination

Images courtesy of: Dr. Hiroyoshi Miyakawa, Dr. Shigeo Watanabe, Tokyo University of Pharmacy and Life Science



Illumination selection turret

The user can choose between DIC illumination and oblique illumination. The oblique illumination direction can be freely adjusted by rotating the incident illumination 360°, making it easy to identify the microelectrode position.

Wavelength selection turret

The user can choose from IR-DIC, visible DIC and brightfield. Deeper tissue penetration into a specimen can be clearly visualized by choosing infrared wavelengths between 850 and 950nm.

Waterproof LWD condenser with increased flexibility

Nikon has developed a new LWD condenser that can easily be switched between brightfield, DIC, and Oblique Light illumination techniques by simply rotating the turret. The new condenser has a long working distance, providing a wide space between it and the specimen. In addition, the condenser surface is waterproof and comes with a solution reservoir to catch spills. The condenser can be easily removed — even if you are using a fixed stage — and it can be cleaned without causing vibration to the manipulator.

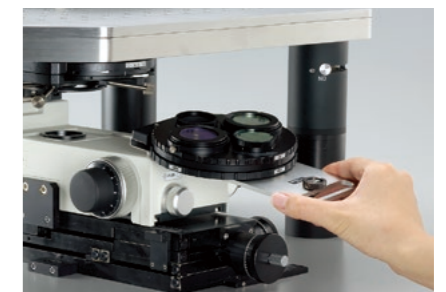

The condenser and polarizer turret can be simply and quickly removed.

Streamlined operation

The focus knob and field diaphragm adjustment are located on the front part of the base to enable efficient focusing. Moreover, there are no cumbersome belts outside the base. The coarse/fine focus knob is located on both the left and right sides, so it can be operated with either hand. In addition, the optional remote handle enables ON/OFF and light intensity adjustment of the fiber illumination from outside the cage.



I-shaped slimline body creates more space above and below the stage

The simple and slim I-shaped body has no projection on the body other than the focus knob, so there is more space in the working area for your experiment. This also provides better access around the microscope to position manipulators and other peripherals. With the eye-point of the body 25mm lower than conventional models, you can work in greater comfort.



Enhanced Noise Reduction and High Responsiveness to a Broad Range of Experimental Needs

Minimizing electronic noise

Nikon has succeeded in significantly reducing electrical noise by utilizing fiber illumination to bring light into the microscope from outside the cage. Noise can be dramatically reduced by connecting ground pins to all main parts of the microscope.

Ultimate vibration noise reduction

Nikon has achieved both improved rigidity and vibration resistance for the FN1 body by undertaking critical measurement and simulation analysis of its structure. Nikon has succeeded in suppressing the vibration generated when the nosepiece or the magnification module is switched.

Compatible with large specimens

The FN1 enables the microscope height to be raised by 10mm to 40mm by inserting up to four 10mm-thick spacers between the body and the arm. This is particularly advantageous for applications that require the observation of larger specimens such as intravital preps.



System Expansion

Confocal Imaging System

Multiphoton Confocal Microscope A1R MP+

With high speed multiphoton confocal imaging up to 720fps with the resonant scanner, A1R MP+ visualizes dynamics deep within living organisms. Unmixing of probes with overlapping spectra is also possible. The high-sensitivity Non-Descanned Detector and CF175 Apochromat 25XC W objectives with superb transmission and aberration correction enable sharp, high-contrast imaging.

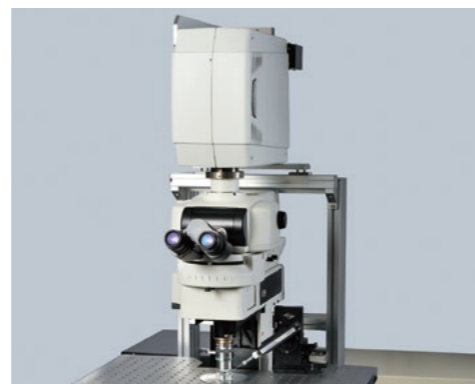

Confocal Microscope C2+ series

C2+ series allows confocal patch-clamp imaging of deep areas of a specimen with excellent operability. Also, elimination of autofluorescence *in vivo* can be easily achieved.



Accessories

LV-TT2 Tilting Trinocular Eyepiece Tube

It delivers erect images as opposed to the inverted images seen through ordinary eyepiece tubes. Its height-adjustable design ensures a comfortable viewing posture even when an intermediate module is mounted.



FN-MT magnification variable turret

Offers flexibility in changing intermediate magnifications between 1X, 1.25X, 1.5X and 2X without moving the objective lens. Vibration-free zooming can be achieved with every FN1 objective lens.



IR-DIC attachment

IR-DIC allows the visualization of minute structure deep within thick tissue of up to 300 or 400µm. Extremely high quality DIC images can be obtained using the IR polarizing set (850-950 nm) with a dedicated IR-CCD camera for image detection.



The IR-CCD camera in the photo is manufactured by Hamamatsu Photonics K. K.

Episcopic illuminators

The NI-FLT6 Epi-Fluorescence Cube Turret accepts 6 filter cubes. Its built-in noise terminator cuts stray light to achieve an exceptionally high signal-to-noise ratio. The CI-FL Epi-Fluorescence Attachment accepts 4 filter cubes.



NI-FLT6 Epi-Fluorescence Cube Turret with NI-FLEI Epi-Fluorescence Attachment and Intensilight HG precentered fiber illuminator



CI-FL Epi-Fluorescence Attachment with mercury lamphouse and power supply

Fiber illumination System

Fiber connection allows the FN1-LH dedicated precentered lamphouse for the FN1 to be located away from the microscope body, reducing heat transfer from the light source to the microscope.



Precentered lamphouse for diascope illumination



Accessories

Near infrared CCD camera C3077-80



C3077-80 configured with C2741-63 camera controller

The C3077-80 is a VGA format CCD camera which has high sensitivity in the near infrared region. Spectral response at 900 nm is more than double that of conventional models. This camera also has EIA output which is widely used in the industry. With its high sensitivity in the NIR region, this camera is suitable for imaging deeper living organisms.

Manufactured by Hamamatsu Photonics K. K.

Exclusive ITS-FN1 stage and mover



When Nikon and Narishige jointly developed the exclusive stage for the FN1, they placed priority on ease of use. The operator can easily sustain the stage in the horizontal position or switch the position of each pair of double magnet pillars and screwed pillars to suit individual experiments. With the microscope XY mover, it is possible to easily and precisely move to the region of interest by translating the whole microscope body in the X or Y axis direction.

Manufactured by NARISHIGE SCIENTIFIC INSTRUMENT LAB.

MT-1000 stage and mover

The pillars of this fixed stage, on which the manipulator and chamber are mounted, are designed as modular, making them compact and easy to customize. They can be freely placed around the mover, allowing effortless access to the microscope. By translating the microscope's optical system with the mover, observation and image acquisition of multiple specimen points are possible.

Manufactured by Sutter Instrument Company



MPC-200 and ROE-200 Manipulators

These electrophysiological manipulators realize stability and highly accurate and smooth operations.

Manufactured by Sutter Instrument Company



System Diagram

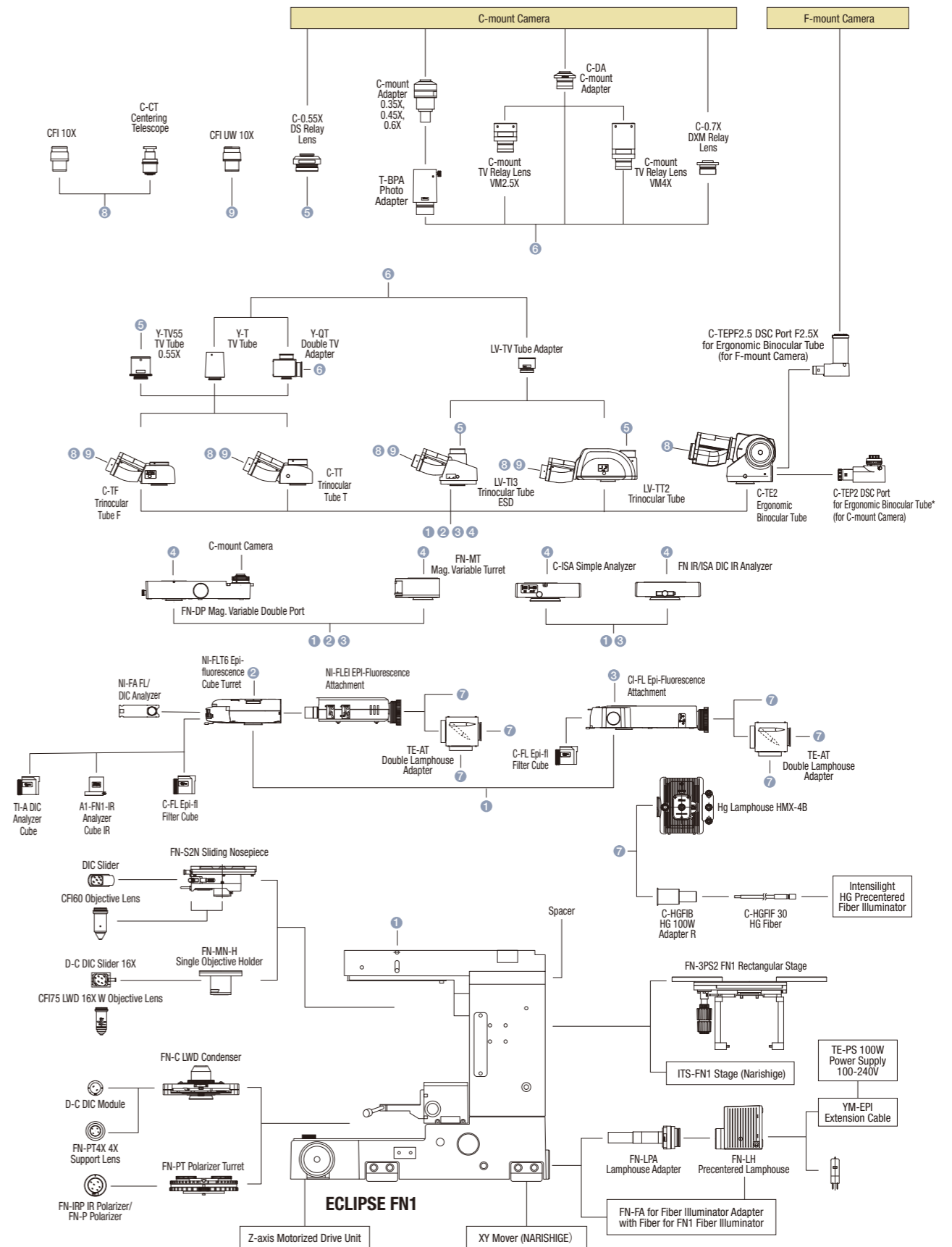

* For the DS-F13 camera, a C-TEP3 DSC Port C-0.55X for Ergonomic Binocular Tube is recommended

Specifications

Optical system	CFI60 and CFI75 infinity optical system
Main body	I-shaped, external power supply
Focusing	Via nosepiece up/down movement Manual coaxial coarse/fine focus knobs (on both sides)
Nosepiece	FN-S2N Sliding Nosepiece (for CFI60 objectives) Front/back 2-position; DIC prism attachable FN-MN-N Single Objective Holder (for CFI75 objective) 1-position; DIC prism attachable
Objectives	CFI Plan 4X NA: 0.10, W.D.: 30.00* CFI Plan Fluor 10X W NA: 0.30, W.D.: 3.50 CFI Apochromat NIR 40X W NA: 0.80, W.D.: 3.50 CFI Apochromat NIR 60X W NA: 1.00, W.D.: 2.80 CFI Plan 100XC W NA: 1.10, W.D.: 2.50 CFI75 LWD 16X W NA: 0.80, W.D.: 3.00 CFI75 Apochromat 25XC W NA: 1.10, W.D.: 2.00
LWD condenser	Universal turret type NA: 0.78, W.D.: 7.20mm DIC and Oblique Light observations possible
Eyepiece	10X, F.O.V.: 22 UW10X, F.O.V.: 25
Eyepiece tubes	C-TE2 Ergonomic Binocular Tube (Bino 100%, Bino : DSC port = 50 : 50) (DSC port cannot be used with variable magnification double port) C-TF Trinocular Tube F (Bino : Photo = 100 : 0, 0 : 100) C-TT Trinocular Tube T (Bino : Photo = 100 : 0, 20 : 80, 0 : 100) LV-TI3 Trinocular Tube ESD (Bino : Photo = 100 : 0, 0 : 100) LV-TT2 Tilting Trinocular Tube (Bino : Photo = 100 : 0, 20 : 80, 0 : 100)
Stage	FN-3PS2 FN1 Rectangular Stage (3-plate mechanical stage) Stroke: 30mm (X, Y)
Light source	Intensilight HG Precentered Fiber Illuminator: 130W long-life mercury lamp Hg Lamphouse: 100W mercury lamp FN-LH Precentered Lamphouse: 12V-100W long-life halogen lamp
Operating conditions	Temperature: +10°C to +40°C Humidity: 85%RH max. (no condensation)
Weight (main body)	Approx. 12kg

* FN-PT4X 4X Support Lens is required.

Company names and product names appearing in this brochure are their registered trademarks or trademarks.
N.B. Export of the products* in this brochure is controlled under the Japanese Foreign Exchange and Foreign Trade Law.
Appropriate export procedure shall be required in case of export from Japan.
*Products: Hardware and its technical information (including software)
Monitor images are simulated.

Specifications and equipment are subject to change without any notice or obligation on the part of the manufacturer. July 2024 ©2024 NIKON CORPORATION



NIKON CORPORATION

Head office

1-5-20, Nishioi, Shinagawa-ku, Tokyo 140-8601, Japan
<https://www.healthcare.nikon.com/en/>

Manufacturer

471, Nagaodai-cho, Sakae-ku, Yokohama, Kanagawa 244-8533, Japan

Nikon Instruments Inc.

1300 Walt Whitman Road, Melville, N.Y. 11747-3064, U.S.A.
phone: +1-631-547-8500; +1-800-52-NIKON (within the U.S.A. only)
fax: +1-631-547-0299

<https://www.microscope.healthcare.nikon.com/>

Nikon Europe B.V.

Stroombaan 14, 1181 VX Amstelveen, The Netherlands
phone: +31-20-7099-000

https://www.microscope.healthcare.nikon.com/en_EU/

Nikon Precision (Shanghai) Co., Ltd.

CHINA phone: +86-21-6841-2050 fax: +86-21-6841-2060
(Beijing branch) phone: +86-10-5831-2028 fax: +86-10-5831-2026
(Guangzhou branch) phone: +86-20-3882-0550 fax: +86-20-3882-0580
<https://www.nikon-precision.com.cn/>

Nikon Canada Inc.

CANADA phone: +1-905-625-9910 fax: +1-905-602-9953

Nikon France, Succursale de Nikon Europe B.V.

FRANCE phone: +33-1-4516-4516

Nikon Deutschland, Zweigniederlassung der

Nikon Europe B.V.

GERMANY phone: +49-211-9414-888

Nikon Italy, Branch of Nikon Europe B.V.

ITALY phone: +39-055-300-9601

Nikon Europe B.V., Amstelveen, Zweigniederlassung Schweiz (Egg/ZH)

SWITZERLAND phone: +41-43-277-2867

Nikon UK, Branch of Nikon Europe B.V.

UNITED KINGDOM phone: +44-208-247-1717

Nikon Österreich, Zweigniederlassung der Nikon Europe B.V.

AUSTRIA phone: +43-1-972-6111

Nikon Singapore Pte. Ltd.

SINGAPORE phone: +65-6559-3651 fax: +65-6559-3668

Nikon Australia Pty Ltd

AUSTRALIA phone: +61-2-8767-6900

Nikon Instruments Korea Co., Ltd.

KOREA phone: +82-2-6288-1900 fax: +82-2-555-4415

Nikon India Private Limited

INDIA phone: +91-124-4688-500

Dimensional Diagram

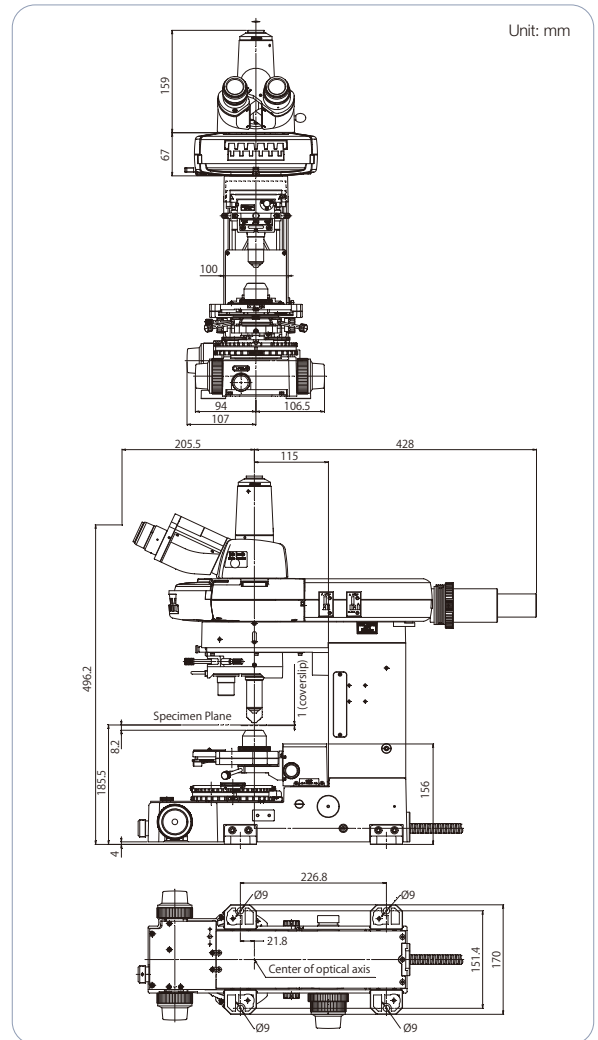

WARNING

TO ENSURE CORRECT USAGE, READ THE CORRESPONDING MANUALS CAREFULLY BEFORE USING YOUR EQUIPMENT.