

## Specifications

Main Body	Optical system	CFI60 infinity optical system
	Field number	22
	Intermediate magnification	Manual switching of 1.0x/1.5x Status detection
	Output port	4 manual positions Eyepiece 100%, left 100%, right 100% Eyepiece 60%/left 40% Status detection
Focusing unit	Coarse/fine focusing knob Coarse motion torque adjustable With refocusing mechanism Stroke: up 4 mm, down 3 mm	
	Tube (field number 22)	
Transmitted illumination	LED Lamphouse for dia illumination	High power LED
	Pillar for dia illumination	Condenser vertical stroke: 66 mm Backward tilting up to 25 degrees With field diaphragm and refocusing mechanism
Condenser	7 motorized positions (ø37 mm x 4, ø39 mm x 3)	
Stage	Stroke range: adjustable in 3 levels with adjusting pin X x Y: ±57 x ±36.5 mm/±36.5 x ±25 mm/±9 x ±9 mm	
Nosepiece	6 motorized positions With DIC prism slots	
Cube Turret	6 motorized positions	
Spindle observation system	2 motorized positions	
Observation method	Brightfield, NAMC, IMSI observation*, Spindle observation*	

\* Compatible with glass-bottom dishes only.

This product complies with the requirements of Regulation (EU) 2017/745 concerning medical devices. Please contact your local distributors or in-country representative for product availability in the country concerned.  
Company names and product names appearing in this brochure are their registered trademarks or trademarks.  
N.B. Export of the products\* in this brochure is controlled under the Japanese Foreign Exchange and Foreign Trade Law. Appropriate export procedure shall be required in case of export from Japan.  
\*Products: Hardware and its technical information (including software)  
Monitor images are simulated.

Specifications and equipment are subject to change without any notice or obligation on the part of the manufacturer. January 2025 ©2025 NIKON CORPORATION



### NIKON CORPORATION

Head office  
1-5-20, Nishio, Shinagawa-ku, Tokyo 140-8601, Japan  
<https://www.healthcare.nikon.com/en/>

Manufacturer  
471, Nagadai-cho, Sakae-ku, Yokohama, Kanagawa 244-8533, Japan

### Nikon Europe B.V.

Stroombaan 14, 1181 VX Amstelveen, The Netherlands  
phone: +31-20-7099-000  
[https://www.microscope.healthcare.nikon.com/en\\_EU/](https://www.microscope.healthcare.nikon.com/en_EU/)  
**Nikon France, Succursale de Nikon Europe B.V.**  
FRANCE phone: +33-1-4516-4516  
**Nikon Deutschland, Zweigniederlassung der Nikon Europe B.V.**  
GERMANY phone: +49-211-9414-888  
**Nikon Italy, Branch of Nikon Europe B.V.**  
ITALY phone: +39-055-300-9601

### Nikon Europe B.V., Amstelveen, Zweigniederlassung Schweiz (Egg/ZH)

SWITZERLAND phone: +41-43-277-2867  
**Nikon UK, Branch of Nikon Europe B.V.**  
UNITED KINGDOM phone: +44-208-247-1717  
**Nikon Österreich, Zweigniederlassung der Nikon Europe B.V.**  
AUSTRIA phone: +43-1-972-6111  
**Nikon India Private Limited**  
INDIA phone: +91-124-4688-500

Code No. 2CE-MUWS-2 (2501)T

## Dimensional diagram

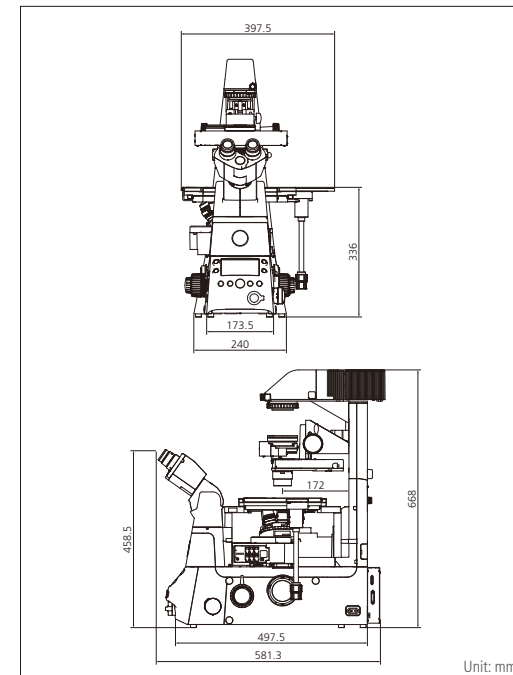

**WARNING**

TO ENSURE CORRECT USAGE, READ THE CORRESPONDING MANUALS CAREFULLY BEFORE USING YOUR EQUIPMENT.

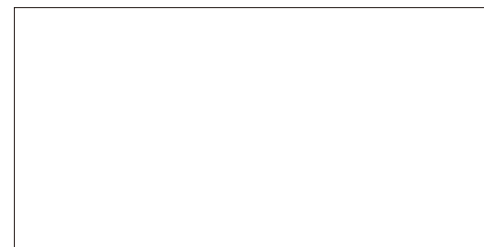

ISO 14001 Certified for NIKON CORPORATION



Motorized Inverted Microscope for ICSI/IMSI

# ECLIPSE Ti2-1

En



# Streamlining the ICSI workflow

In ICSI, speed and preciseness are indispensable, and microscopes that support ICSI must be extremely reliable and enable accurate control with simple operations. The ECLIPSE Ti2-I realizes motorized switching of observation modes to meet embryologists' needs. It simplifies the complicated microscope control of conventional models, and contributes to improvement of productivity with intuitive operability. The ECLIPSE Ti2-I provides new solutions to optimize ICSI workflows and supports an enhanced user experience.

## Improving Workflow Efficiency

The ECLIPSE Ti2-I includes new features to simplify your workflow and streamline your processes

## Easy Operation

Microscope control with minimal operation to save you time at the microscope

## Unique Design to Increase Confidence

Intuitive design with clear visibility of the microscope settings for your convenience

## High Optical Quality

Nikon's renowned optics provide high levels of clarity and overall optical performance



## Improving Workflow Efficiency

New Nikon solution to simplify your workflow

### Settings integrated into one button for your convenience

With conventional microscopes, it was necessary to operate and optimize multiple parts of the microscope for each observation mode, such as oocyte observation or sperm injection. However, with the ECLIPSE Ti2-I, microscope optical settings for switching observation modes are integrated into a single button. This can be completely programmed to user preferences; even complex microscope operations can be completed with one touch.

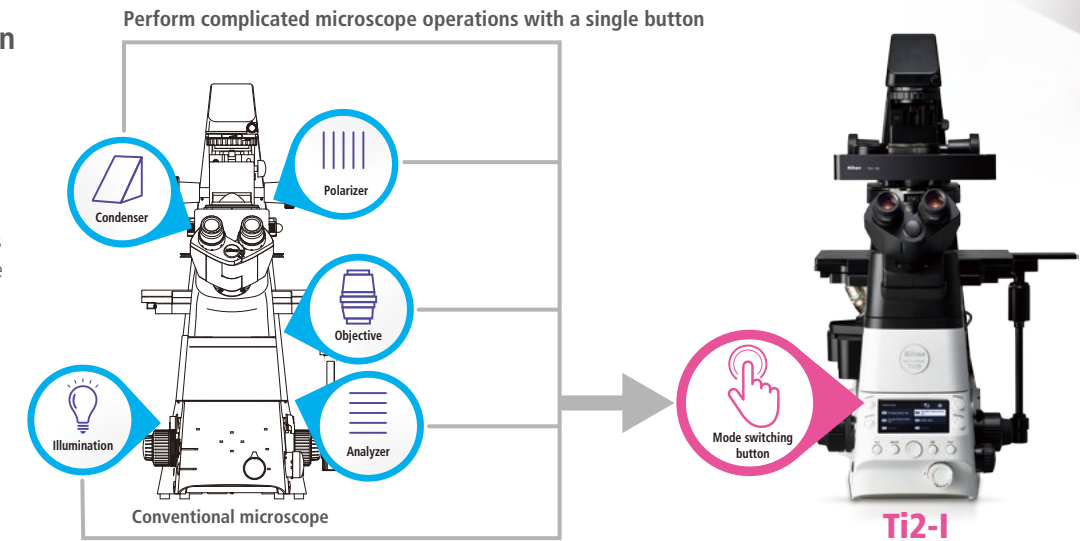

### Simplified ICSI workflow

Microscopes require specific settings for each observation during assisted reproduction techniques (ART) such as ICSI and IMSI. The ECLIPSE Ti2-I requires only one button press to alter multiple settings when changing observations. This dramatically refines the workflow and improves efficiency in ICSI which requires frequent changes in observation methods.

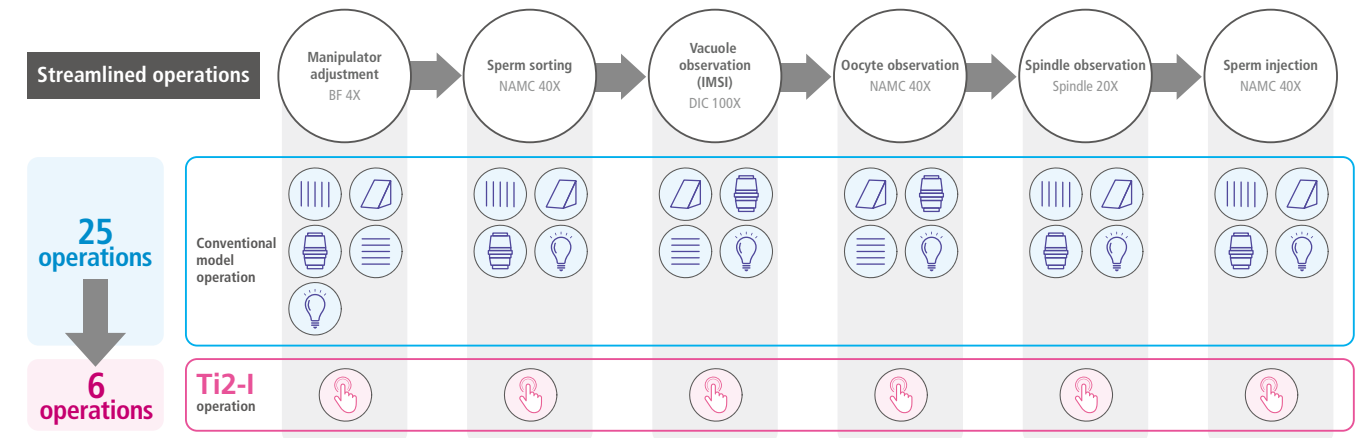

The workflow shown is an example for the purpose of illustration only.

## Easy Operation

Microscope control with minimal operation

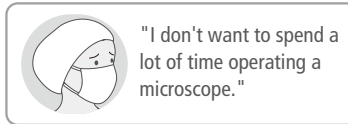

**New ECLIPSE Ti2-I**

- Motorized observation mode switching
- Automatically reproduce the adjusted brightness



### Motorized observation mode switching

Control systems such as buttons are all in one place for ease of use. Motorized observation mode switching is available with just one push of a button. The microscope can be operated with minimal hand movements, allowing you to focus completely on ICSI technique.

Observation modes can be allocated to four mode buttons and two function buttons. This enables registration for observations at different magnifications, IMSI or spindle observations, and also supports the introduction of other types of observation such as laser observation.



Buttons can be operated while looking through the microscope.

Switch observation mode with **one touch**



### Automatically reproduce the adjusted brightness

The ECLIPSE Ti2-I includes the light intensity management (LIM) function developed by Nikon. This automatically stores any changes to brightness settings which helps avoid drastic changes in brightness when switching magnification or observation mode, improving work efficiency and helping to mitigate eye strain.

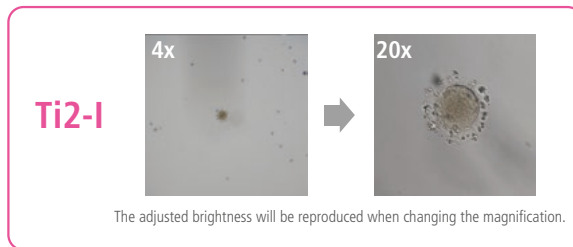
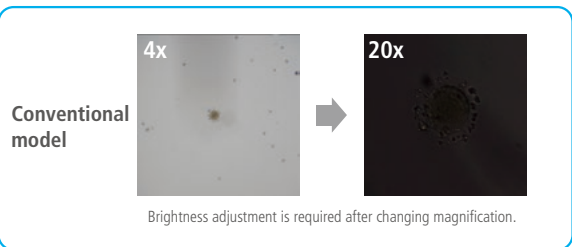

## Unique Design to Increase Confidence

Intuitive design with visibility of microscope settings



**New ECLIPSE Ti2-I**

- Display showing microscope status
- Alerts on setting errors



### Display showing microscope status

The currently selected observation mode can be easily checked on the LCD display. The settings are clear and easy to understand for all users of the microscope. The registration settings for each mode can be confirmed using intuitive icons on the detailed information screen.

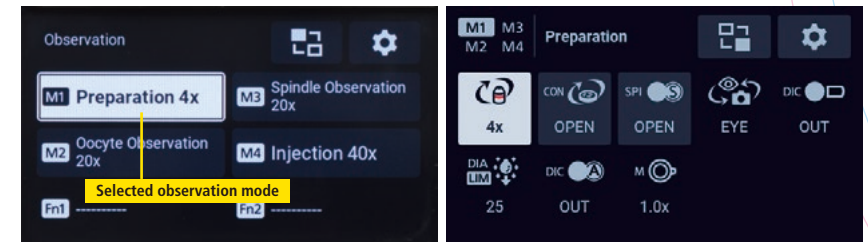

Detailed information screen



### Alerts on setting errors

If the microscope settings do not match the registered configuration, warnings will be displayed. You can check on the screen where you need to make corrections. This makes it easier to notice setting errors and reduces operational mistakes.

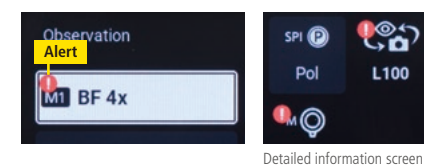

Detailed information screen



## High Optical Quality

Renowned high-quality optics for detailed observation



New ECLIPSE Ti2-I



Color display of spindle in all directions



Achieving clearer and brighter observation



### Color display of spindle in all directions

The ECLIPSE Ti2-I is compatible with spindle observation. With this technique, the spindle is displayed in red or blue and can be clearly identified. As it is an omnidirectional method, the spindle is easy to see, even if the orientation of the oocyte is changed. This is a powerful tool to support those who want to capture spindles reliably.

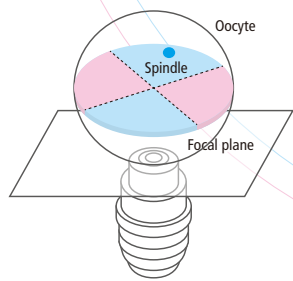

Using circularly polarized light, the spindle in the focal plane is displayed in color in all directions.

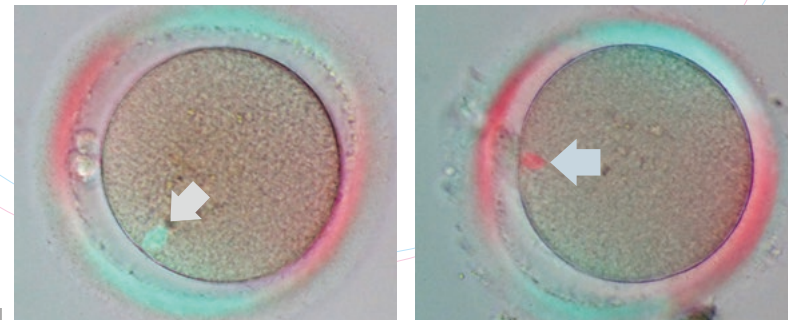

The spindle is represented in color even while the oocyte is rotated, making the spindle easy to identify.

Image courtesy of: Reproduction Clinic Tokyo  
The image was obtained with our other model.



### Achieving clearer and brighter observation

The brightness of the field of view when looking through the eyepiece has been significantly improved. You can observe oocytes and sperm more clearly than ever before. Nikon's high-quality objectives enable observation of colorless and transparent oocytes and sperm by adding relief-like shading.

#### IMSI observation

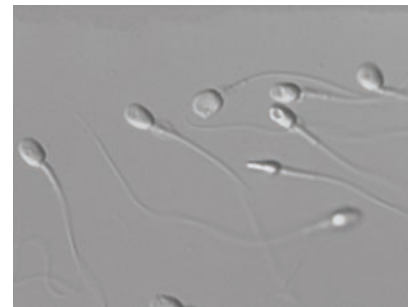

Vacuoles in the sperm head can be observed. (100X objective)  
Image courtesy of: Fujita Health University

The 60X and 100X objectives allow for clear identification of fine structures, making them ideal for IMSI.



CFI S Plan Fluor ELWD 60XC (left)  
CFI Plan Achromat LWD IMSI 100XC (right)

#### Nikon Advanced Modulation Contrast (NAMC) observation

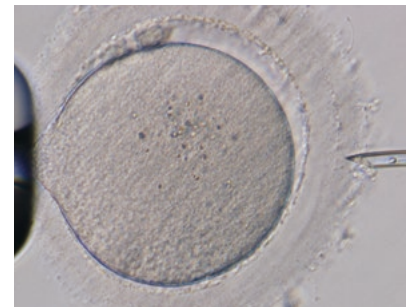

A sperm in the pipette can be clearly observed.  
Image courtesy of: The Ronald O. Perleman and Claudia Cohen Center for Reproductive Medicine  
The image was obtained with our other model.

The direction of contrast can be adjusted by rotating the modulator in the objective. Plastic dishes can be used.



CFI S Plan Fluor ELWD NAMC 40XC (left)  
CFI Achromat LWD NAMC 40XC (right)

## Supporting ICSI through increasingly improved operability

The ergonomic tube enables the eyepiece height to be adjusted to the user's eye point, ensuring a comfortable posture.

The touch panel LCD display allows the observation mode to be switched by touching the observation mode name. The touch panel display can be operated even with gloves on, reducing operation time.

The intermediate magnification switching knob enables images to be magnified 1.5x while maintaining image quality, without the need to change objectives.

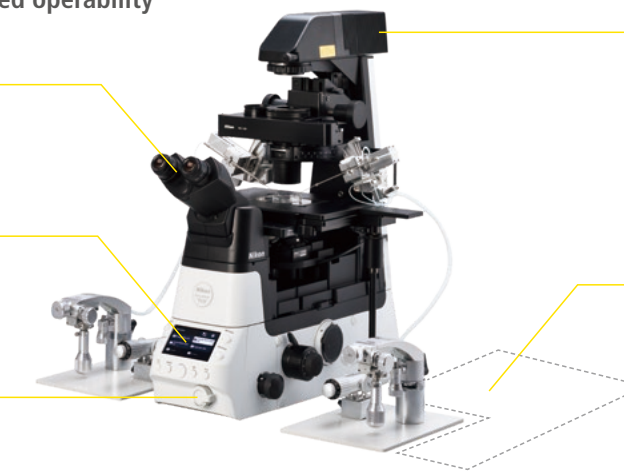

Long-life LED illumination provides bright images even during high-magnification observation. Recording and automatic reproduction of adjusted brightnesses has also been achieved.

Since the operating buttons are provided on the microscope body, no external controller is required. The space-saving design of the ECLIPSE Ti2-I with a built-in control box for the motorized units allows effective use of space on the clean bench.

### System diagram

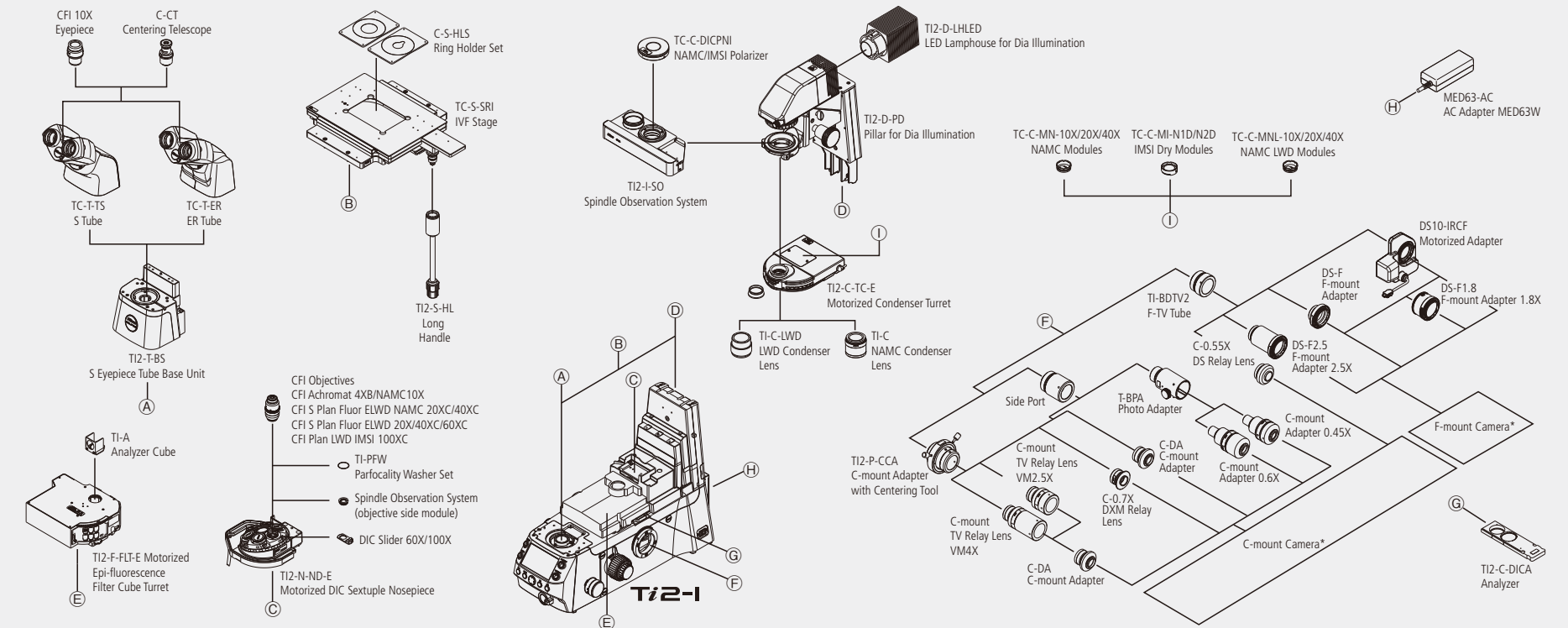

\*The microscope cameras are not for medical purpose.