



AX/AX R with NSPARC

AX AX R with NSPARC

Confocal based Super Resolution Microscope



Shedding New Light On **MICROSCOPY**

Igniting New Confocal Imaging Potential

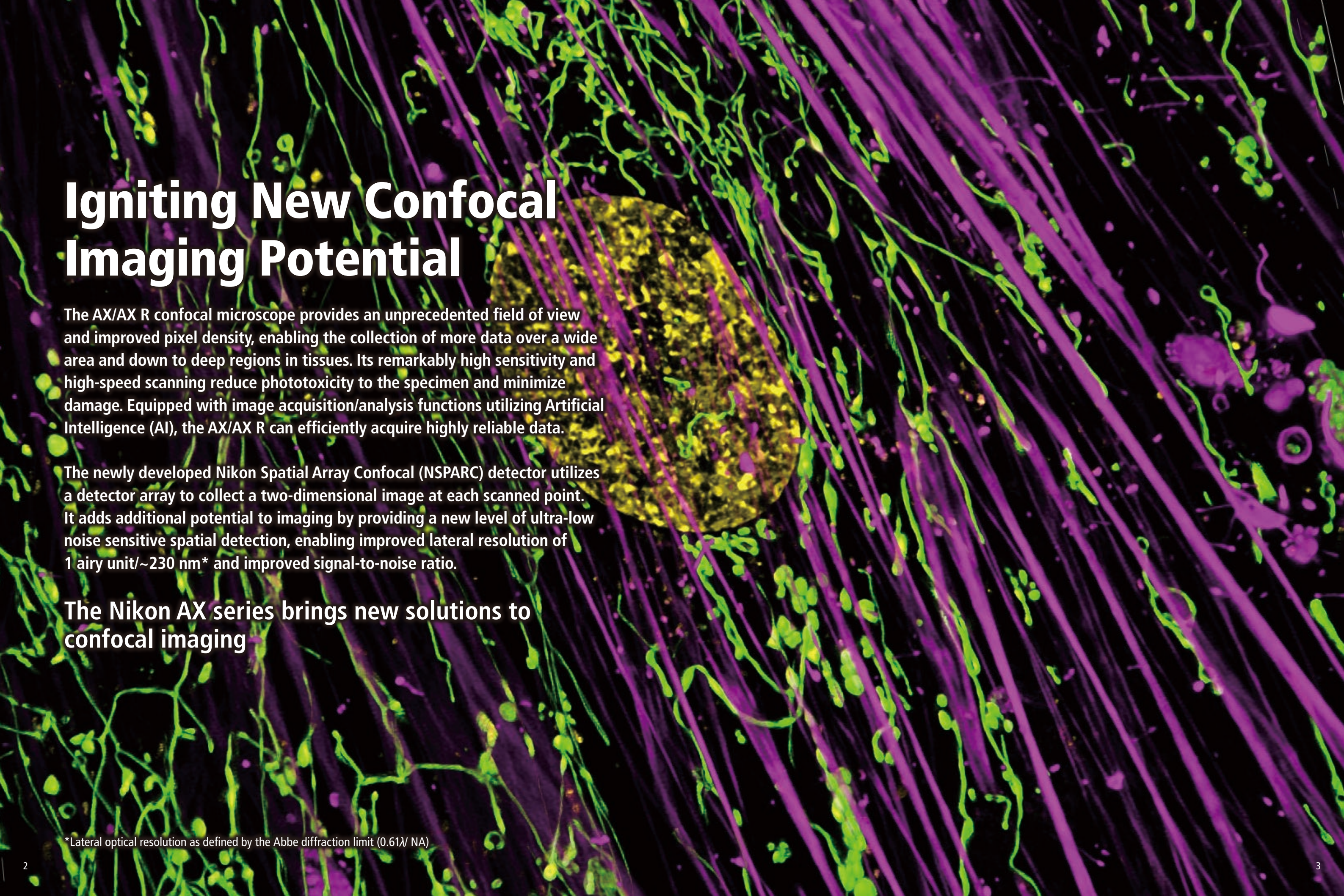

The AX/AX R confocal microscope provides an unprecedented field of view and improved pixel density, enabling the collection of more data over a wide area and down to deep regions in tissues. Its remarkably high sensitivity and high-speed scanning reduce phototoxicity to the specimen and minimize damage. Equipped with image acquisition/analysis functions utilizing Artificial Intelligence (AI), the AX/AX R can efficiently acquire highly reliable data.

The newly developed Nikon Spatial Array Confocal (NSPARC) detector utilizes a detector array to collect a two-dimensional image at each scanned point. It adds additional potential to imaging by providing a new level of ultra-low noise sensitive spatial detection, enabling improved lateral resolution of 1 airy unit/ ~ 230 nm* and improved signal-to-noise ratio.

The Nikon AX series brings new solutions to confocal imaging

*Lateral optical resolution as defined by the Abbe diffraction limit ($0.61\lambda/NA$)

See More of the Specimen

With the largest field-of-view on both inverted and upright microscope stands available (25 mm diagonal), more specimens fit in one FOV with more objective lens choices than ever before. Coupled with scanning sizes up to 8192 x 8192 pixels, sampling beyond the optical diffraction limit is possible even at low magnifications with the AX/AX R.

Using lower magnifications with longer working distances and high numerical apertures enables more flexible specimen preparations to be used, while the large FOV allows simultaneous high resolution in one image. Collect more data in every image, and at faster rates.

This high throughput is beneficial in not only academic research but also drug discovery research.

The AX/AX R has a 25 mm diagonal FOV, much larger than other confocal instruments.

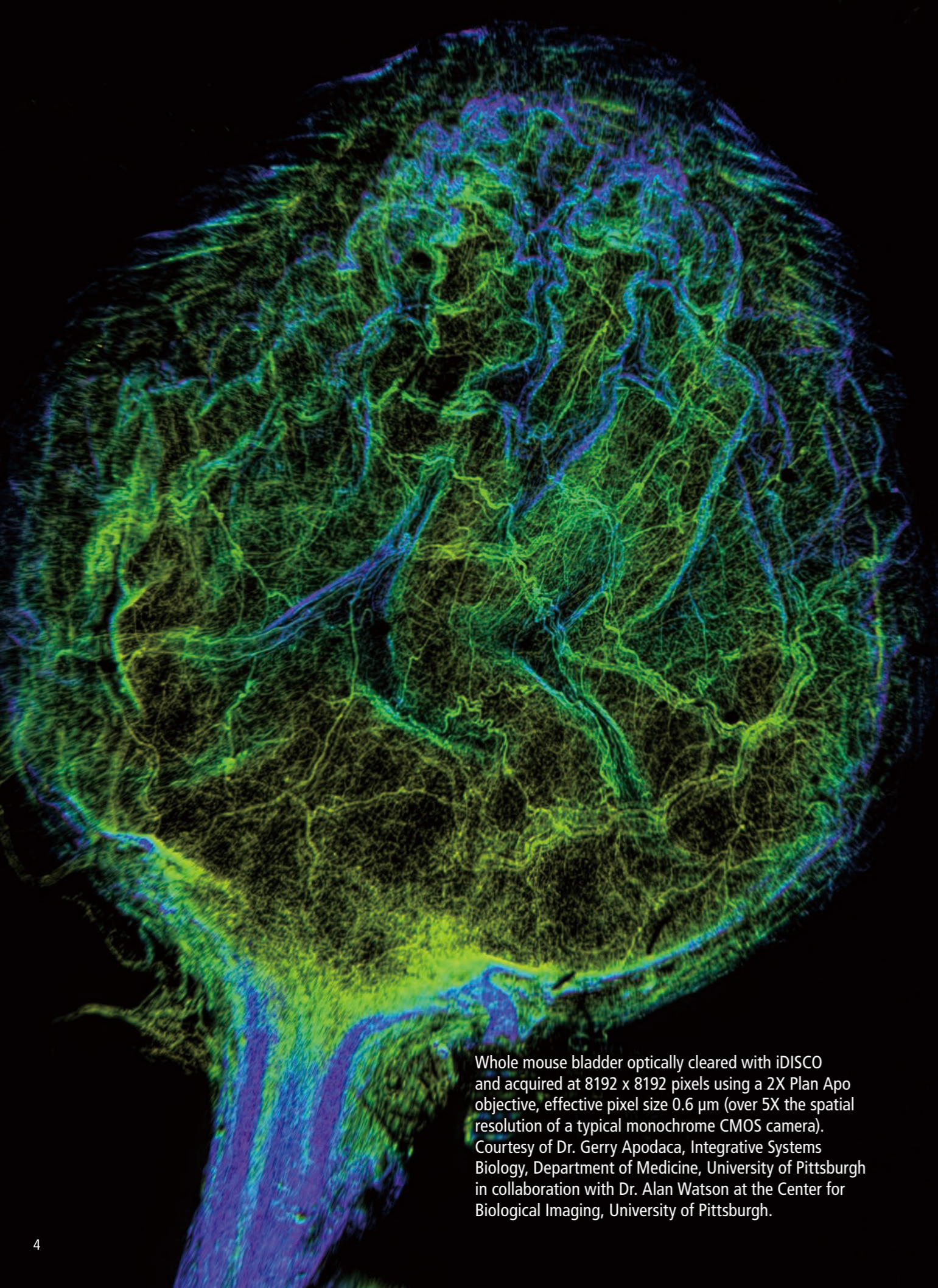

Whole mouse bladder optically cleared with iDISCO and acquired at 8192 x 8192 pixels using a 2X Plan Apo objective, effective pixel size 0.6 μm (over 5X the spatial resolution of a typical monochrome CMOS camera). Courtesy of Dr. Gerry Apodaca, Integrative Systems Biology, Department of Medicine, University of Pittsburgh in collaboration with Dr. Alan Watson at the Center for Biological Imaging, University of Pittsburgh.

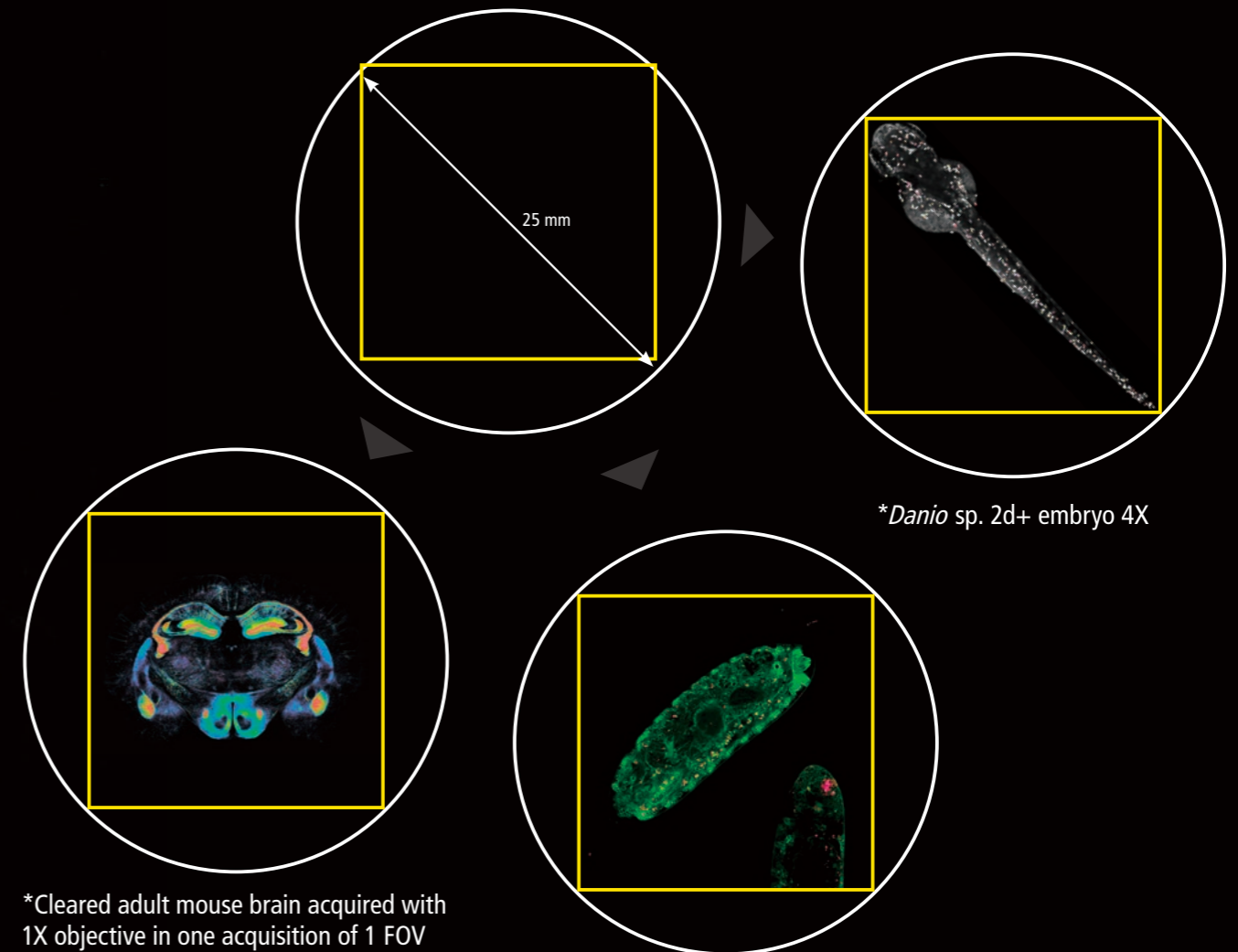

**Danio* sp. 2d+ embryo 4X

*Cleared adult mouse brain acquired with 1X objective in one acquisition of 1 FOV

**Drosophila* sp. embryo development easily fits within the FOV using a high NA 25X SIL 1.05 NA objective

*It would not be possible to capture this sample in one FOV or at this resolution with other commercial confocal systems

Observe with Minimal Disturbance...

Laser scanning confocal imaging is principally challenging on specimen viability, as it applies focused laser illumination point by point on a sample.

The AX R's high speed resonant scanning, which decreases the illumination time by more than 20X typical confocal scanning times, greatly reduces biases caused by merely acquiring images.

Reducing the acquisition time also allows for extremely high-speed imaging (up to 720 fps at 2048 x 16 pixels).

The result: longer time-lapse imaging and/or more frequent high-speed imaging of living samples that enables dynamic events to be captured. This is useful for imaging living samples, and dramatically increases the efficiency of such drug discovery research as multipoint assays.

Time-lapse Z series maximum intensity projection images of a developing *Drosophila* embryo expressing PLC-PH::GFP (PIP2) acquired every 10 minutes for 12 hours at 2K x 1K pixels using a 25X silicone immersion objective. Courtesy of Yang Hong Laboratory, Department of Cell Biology, University of Pittsburgh in collaboration with the Center for Biological Imaging.

...and Acquire more Rapidly...

Confocal imaging, notoriously slow because of its point-scanning requirement for high quality 3-dimensional imaging at high resolution, is greatly changed by fast imaging with the AX R's resonant scanning capabilities.

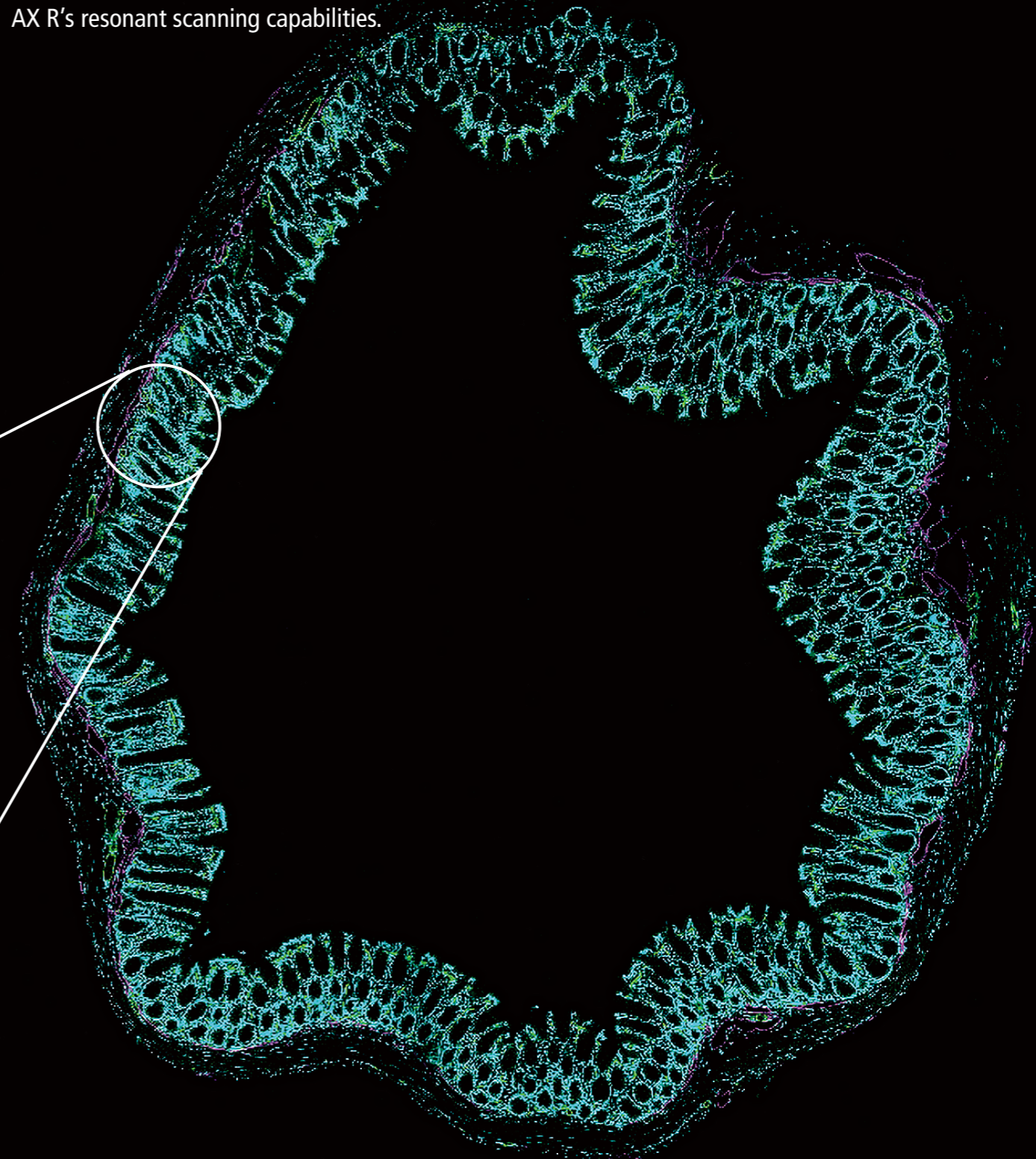
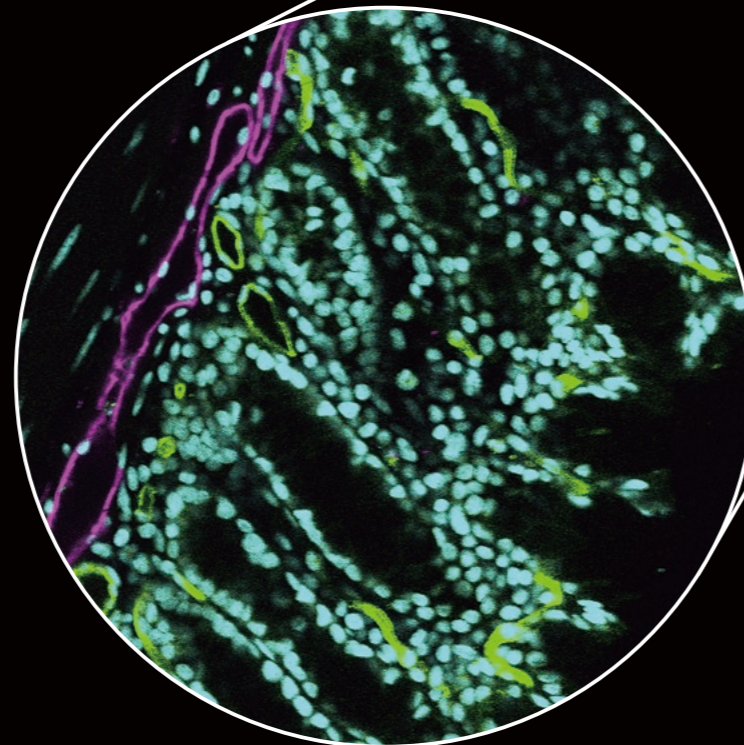

Utilizing 2048 x 2048 pixel resonant scanning and a 25 mm FOV on a large intestinal sample montage, acquiring 25 high-resolution images and merging them in under 2 minutes

...and with Ultrafine Detail

With a full 25 mm FOV, up to 8192 x 8192 pixels, and the capability for supravideo frame rates, the AX/AX R allows for spectacular imaging with high resolution, at both low and high magnifications.

The entire range of a whole organism or system biology down to intracellular imaging is achievable on one instrument.

This high resolution capability is beneficial for target selection in drug discovery.

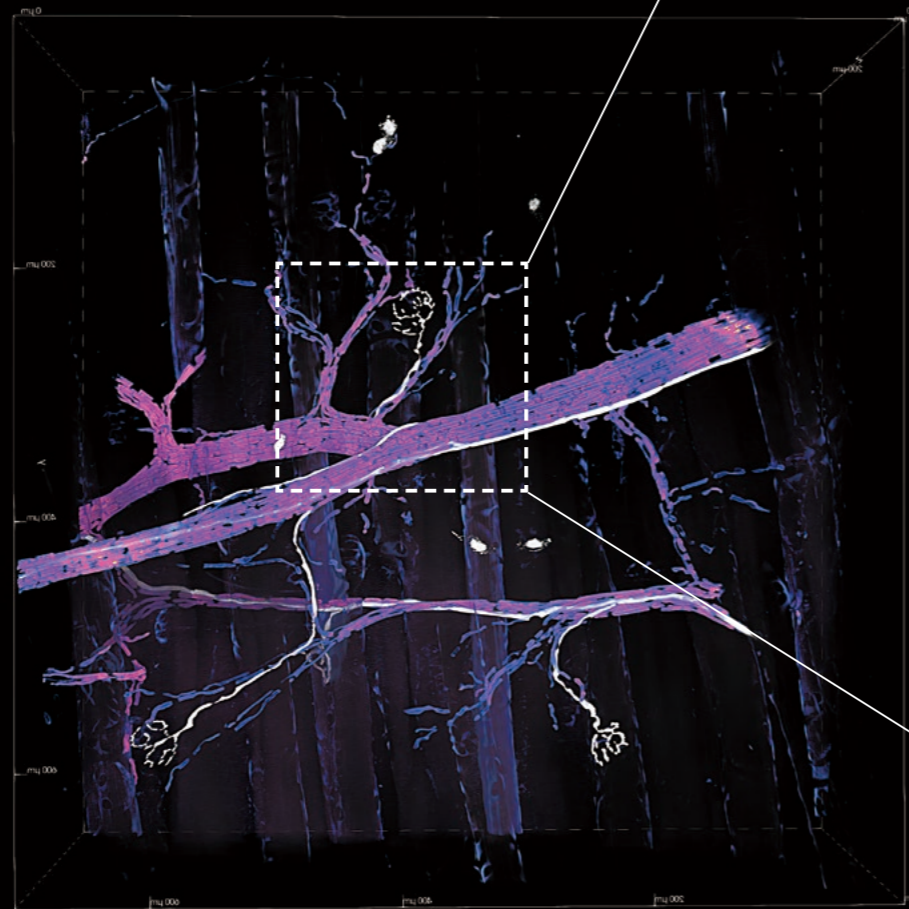

3 dimensional reconstruction Z series (color coded by Z depth) of microglial movement in developing zebrafish, obtained with high speed resonant imaging and piezo Z stepping. Courtesy of Dr. E. Burton, Department of Neurology, University of Pittsburgh.



Mouse muscle acquired with a 25X SIL immersion objective using 2048 x 2048 pixel resonant scanning

Detectors In Tune with Labels

The AX/AX R's all new DUX-VB detector custom-tunes emission bandwidths to a library of labels and probes, and provides the freedom to fine-tune emission bands to minimize unwanted fluorescence. Simply select the number of labels in your specimen and their catalog names. Alternatively, you can define the desired emission ranges, or even simply the emission color: the AX/AX R and NIS-Elements software does the rest, including optimizing the dichroic mirror and laser excitation choices best suited for imaging. Or, acquire hyperspectral images in up to 66 emission channels for unmixing.

Optionally, the AX/AX R's base DUX-ST detector allows up to 12 discreet bandpasses of emission, upgradable to 18.

And all detector systems can be customized with high sensitivity and low noise GaAsP or Multi-alkali PMT detectors to provide the best detector for sensitivity and wavelength response requirements as well as budgets.

Maximum intensity projection of Z stack images of marmoset brain acquired with a 60X 1.27 NA water immersion objective using 2048 x 2048 pixel resonant scanning and a DUX-VB detector with user-defined emission bands.

Superior Optics for Confocal imaging

Controlling the manufacturing and implementation of optics from raw materials all the way to complete microscope systems brings unparalleled optical quality and performance. Complementary optical design means the confocal system, microscope, and objectives all are optimized and matched for superior quality and resolution. Nikon's CFI60 and 75 infinity corrected optical system has numerous options for magnifications, working distances, and immersion mediums, paired for use with an extremely wide variety of samples and specimen preparations.



CFI Plan Apochromat Lambda S 25XC Sil/40XC Sil

Using silicon oil as the immersion liquid when imaging objects having a refractive index of around 1.4 enables this lens to acquire high quality images with reduced spherical aberration, even with thick samples.



CFI Apochromat LWD Lambda S 20XC WI/40X WI

This objective corrects chromatic aberrations in a wide wavelength range from visible to near-IR light. With its high numerical aperture, as well as long working distance, it is a powerful tool for imaging thick living specimens.



CFI Plan Apochromat Lambda D 10X

This objective provides superb aberration correction up to the periphery of its large 25 mm field of view, enabling sharp image acquisition of entire samples with digital cameras that have large image sensors. It also corrects chromatic aberration over a wide wavelength range.



CFI Plan Apochromat VC 60XC WI

A water immersion objective that ensures clear image acquisition even within the deep areas of samples. It corrects chromatic aberrations in the shorter wavelength range and is suitable for multicolor confocal imaging.

Maximum intensity projection of Z stack images, color-coded by depth, of vascular development in embryonic zebrafish acquired with a 10X 0.45 NA Plan Apo Lambda S objective using 1024 x 2048 pixel resonant scanning. Courtesy of Erika Dreikorn and Dr. Beth Roman, Department of Human Genetics, University of Pittsburgh Graduate School of Public Health.

3D Confocal Imaging with Super Resolution

NSPARC's array detection enables simultaneous collection of multiple sampling of emission light per pixel, which is beneficial in the Z direction as well as laterally and improves axial resolution.

As a user can optically restrict the emission to the NSPARC detector, confocal imaging can be achieved with a high signal-to-noise ratio, even for 3D observation of thick samples such as cranial nerves, organoids, and organ chips.

Nikon provides various objectives to match specimens, including silicon immersion objectives to minimize refractive index mismatches. Coupled with the AX/AX R's ultra-large 25mm FOV, the system supports a wide selection of objectives capable of obtaining image data from large overviews down to extremely fine details, which can then be measured and analyzed.

3-dimensional super resolution

NSPARC can acquire not only horizontal but also axial super-resolution images.

CFI Plan Apochromat
Lambda D 60X Oil (NA 1.42)



High resolution

Confocal imaging captures sample details in high resolution.

CFI Plan Apochromat
Lambda D 20X (NA 0.8)



Traditional Detector

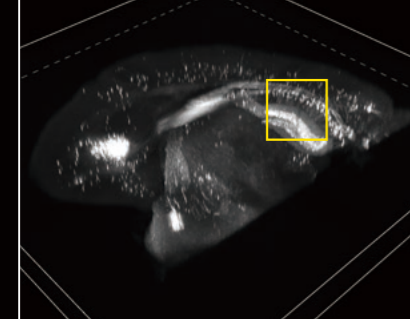

Traditional Detector

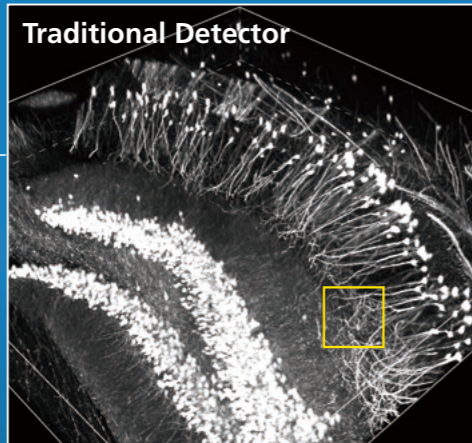

Large FOV

Large FOV confocal mode and NSPARC super-resolution mode can be switched.

CFI Plan Apochromat
Lambda D 4X (NA 0.2)

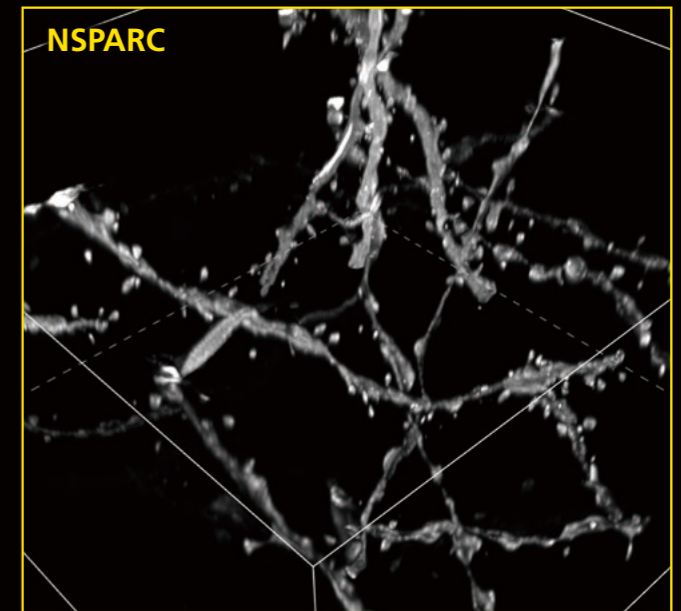
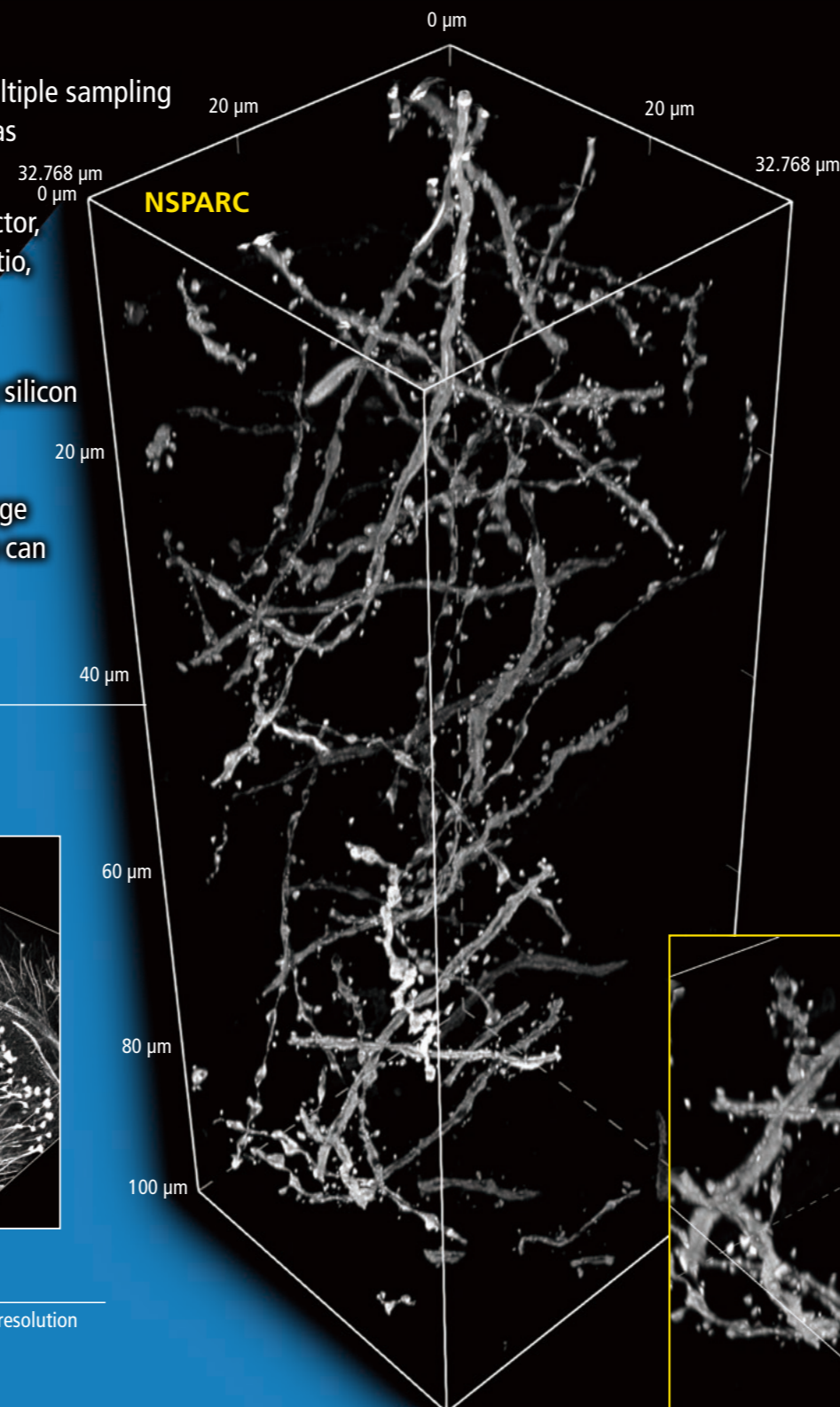

Surface: 0~20 μm

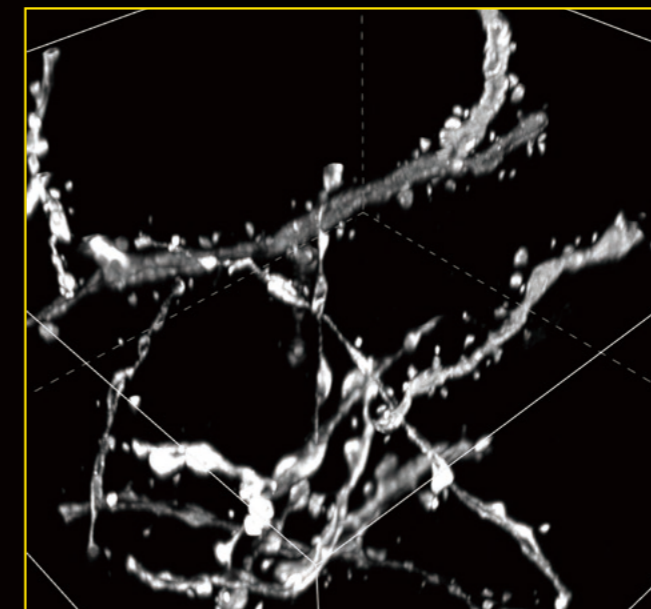

Middle: 40~60 μm

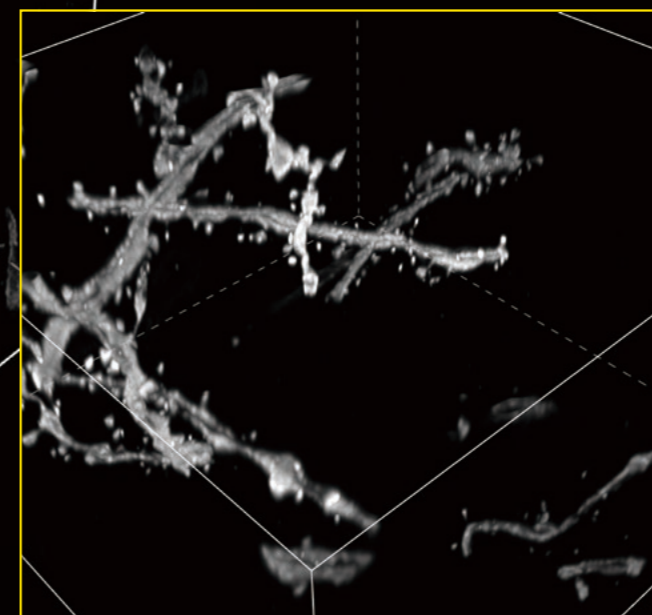

Deep: 80~100 μm

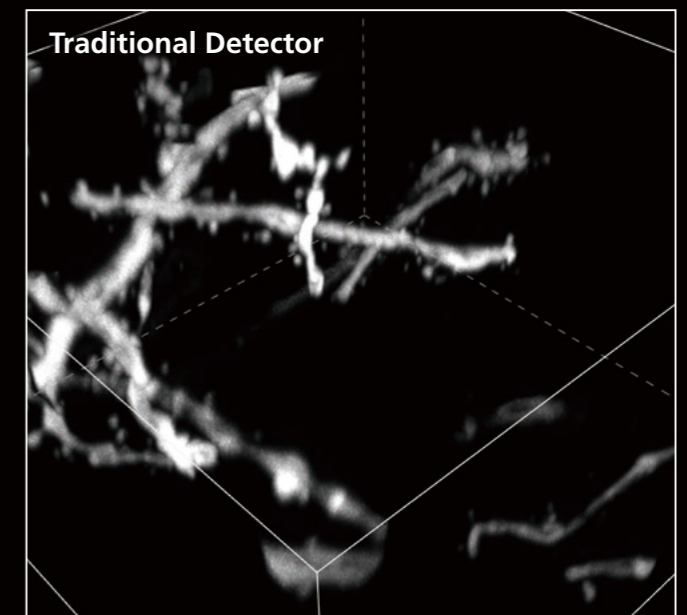

Thy1-EGFP mouse neuron (optically cleared)
Sample courtesy of: Lin Daniel, PhD. SunJin Lab Co.

Low Noise, High Sensitivity Detection

NSPARC's sensitivity, combined with ultra-short dwell time resonant imaging with the AX R resonant scanner, allows longer, less phototoxic imaging data to be collected in live-cell assays. As an added benefit, additional spatial information is acquired for every pixel using the detector array, which can be used to further enhance resolution and brightness.

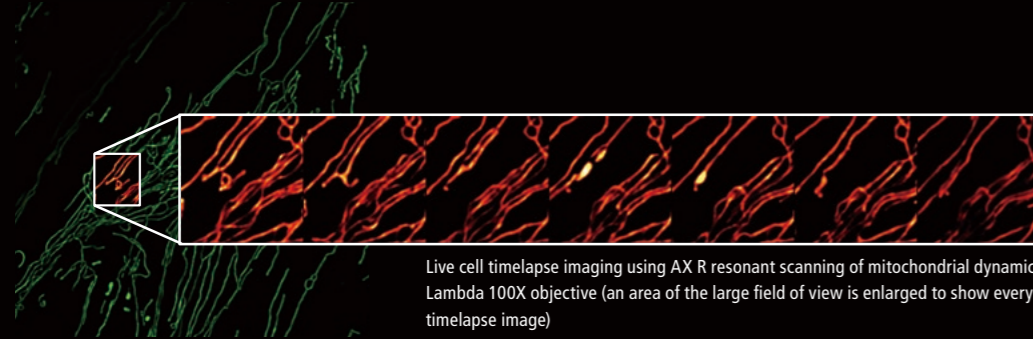

Live cell timelapse imaging using AX R resonant scanning of mitochondrial dynamics using a CFI Plan Apochromat Lambda 100X objective (an area of the large field of view is enlarged to show every 10th frame of a fast acquisition timelapse image)

High Speed Imaging with Improved Sensitivity

The NSPARC detector, which has the capability to detect single photons, features an extremely low noise profile and exceptional sensitivity, making it a perfect match for AX R confocal resonant high-speed imaging with a pixel dwell time as short as 200 nanoseconds, enabling image acquisition at video frame rates. More details can be extracted from images for downstream analysis and computation.

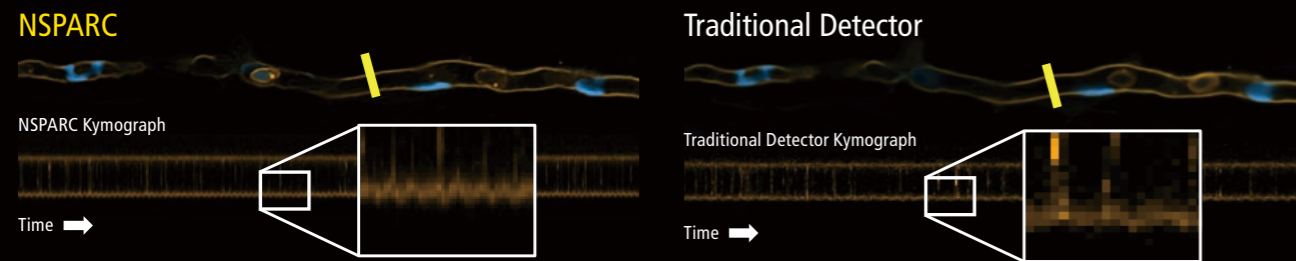

Video-rate timelapse imaging with AX R of zebrafish vasculature was performed using NSPARC and conventional detectors to compare their sensitivities. Imaging kymographs were created (yellow lines) across a vessel in order to visualize the vessel endothelium position over time. Because of its array detection and increased SNR, the NSPARC kymograph more clearly displays the pulsatory nature of the endothelial layer over time, in comparison to a conventional GaAsP detector.

Fast Image Acquisition of Large Areas

When the NSPARC detector is combined with the AX R resonant scanner, super-resolution images of large areas of 2048 x 2048 pixels can be acquired at high speed (approximately 6 times* faster than with a galvano scanner). Rapid changes of dynamic structures can be captured with increased sensitivity and resolution over larger areas.

* When using the CFI Plan Apochromat Lambda D 60X Oil objective and a 2.5X zoom.

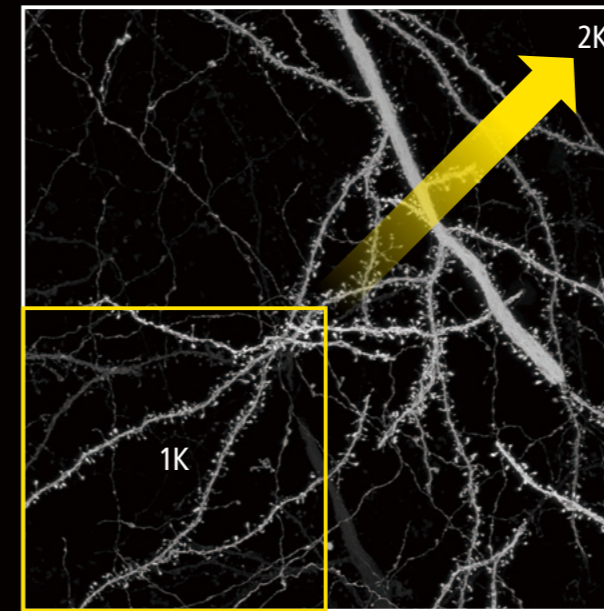

For the same pixel size, a 2K x 2K pixel image provides four times the area of a 1K x 1K pixel image.

Thy1-EGFP mouse neuron (after tissue clearing)
Sample courtesy of: Lin Daniel, PhD, SunJin Lab Co.

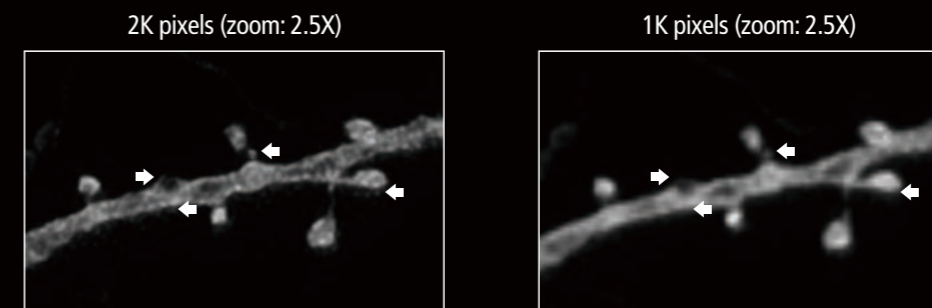

For the same imaging area, a 2K x 2K pixel image provides higher image resolution than a 1K x 1K pixel image.

NSPARC Spatial Array Detector Technology

Where a point scanning detector traditionally produces an intensity output only for each pixel, NSPARC comprises an array of 25 detectors that operates more like an extremely sensitive camera: two-dimensional spatial information from each scanned pixel is collected by the detector.

Optical lenses direct emission light to the detector, allowing it to be used with various objectives and magnifications, while simultaneously allowing the user to define the size of the illumination spot on the detector array. This enables oversampling of the conventional single airy unit emission from the confocal plane.

This two-dimensional information is immediately used to obtain ultra-fine structural information, which is lost in conventional detection.

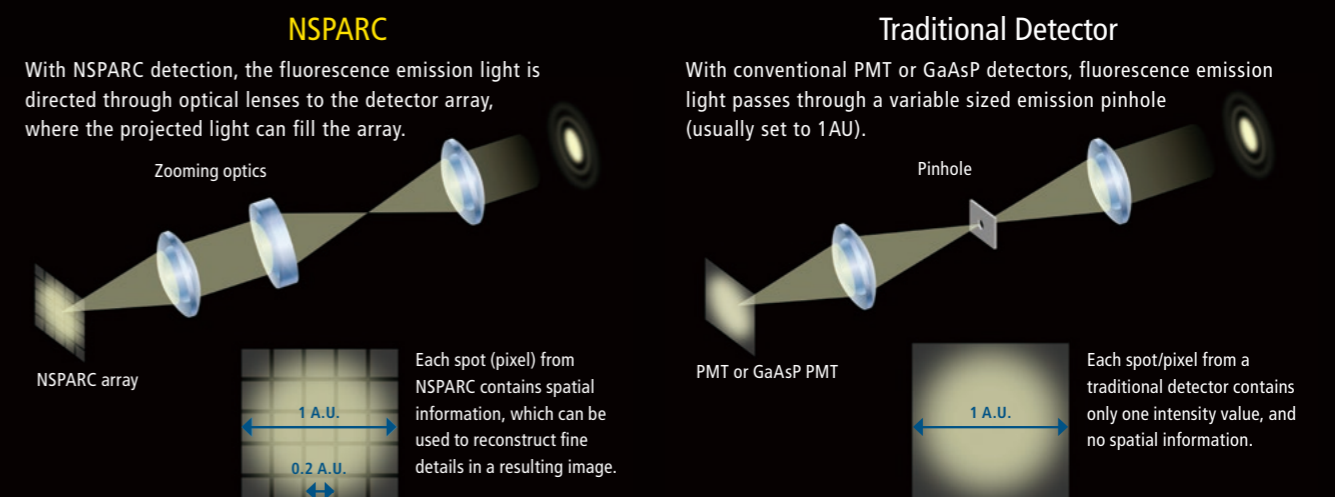



Comprehensive Imaging Software

NIS-Elements Imaging Software allows integrated control of microscopes and peripheral devices, as well as confocal systems. In addition to various functions for confocal imaging, it has a wide range of AI tools that support streamlining of image analysis and optional modules that enable customization of analysis and experiment workflows.



C-ER (Extended Resolution)

NIS-Elements C-ER can be used to improve confocal spatial resolution up to 120 nm (lateral)/300 nm (axial) using GPU-processing with automatic parameter settings and user-defined options.

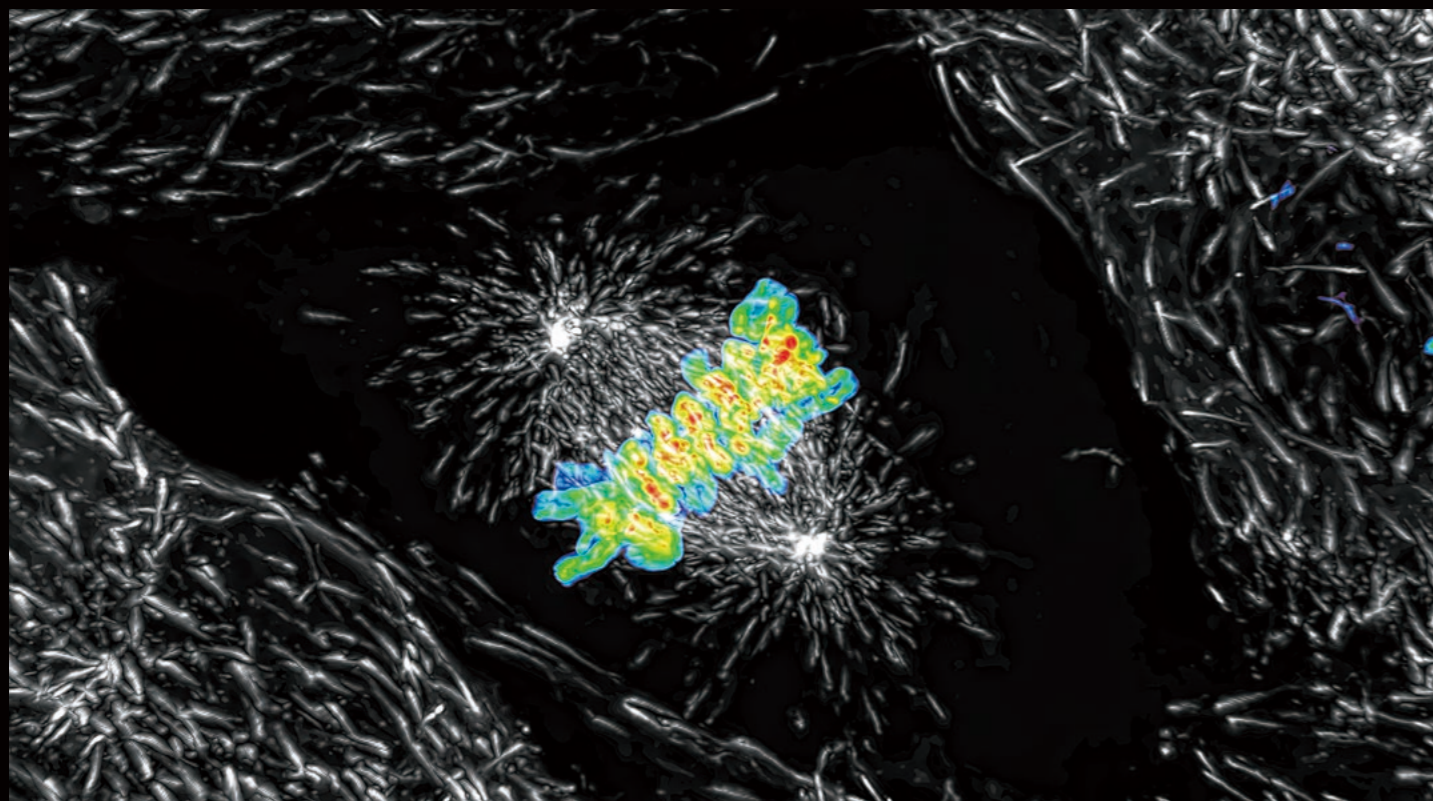

Maximum intensity projection of Z stack images of a live sample to which ER has been applied, acquired with a 60X 1.4 NA Plan Apo Lambda oil immersion objective using 2048 x 1024 AX R resonant scanning at 15 fps.



Customized Definition of Experiments

NIS-Elements has built-in multidimensional (multi-XYZ,T, multichannel) experiment capabilities. Adding the optional JOBS module allows even more customization such as setting up non-orthogonal experiments with multiple paths and dimensions.

Oftentimes, experiments require customization to streamline acquisition and capture all necessary data points.

Analysis of data can be done even in real-time during the experiment, and the direction of the experiment can even be changed based on the results of the analysis.

Users have ultimate flexibility in designing experiments that maximize their data output needs.

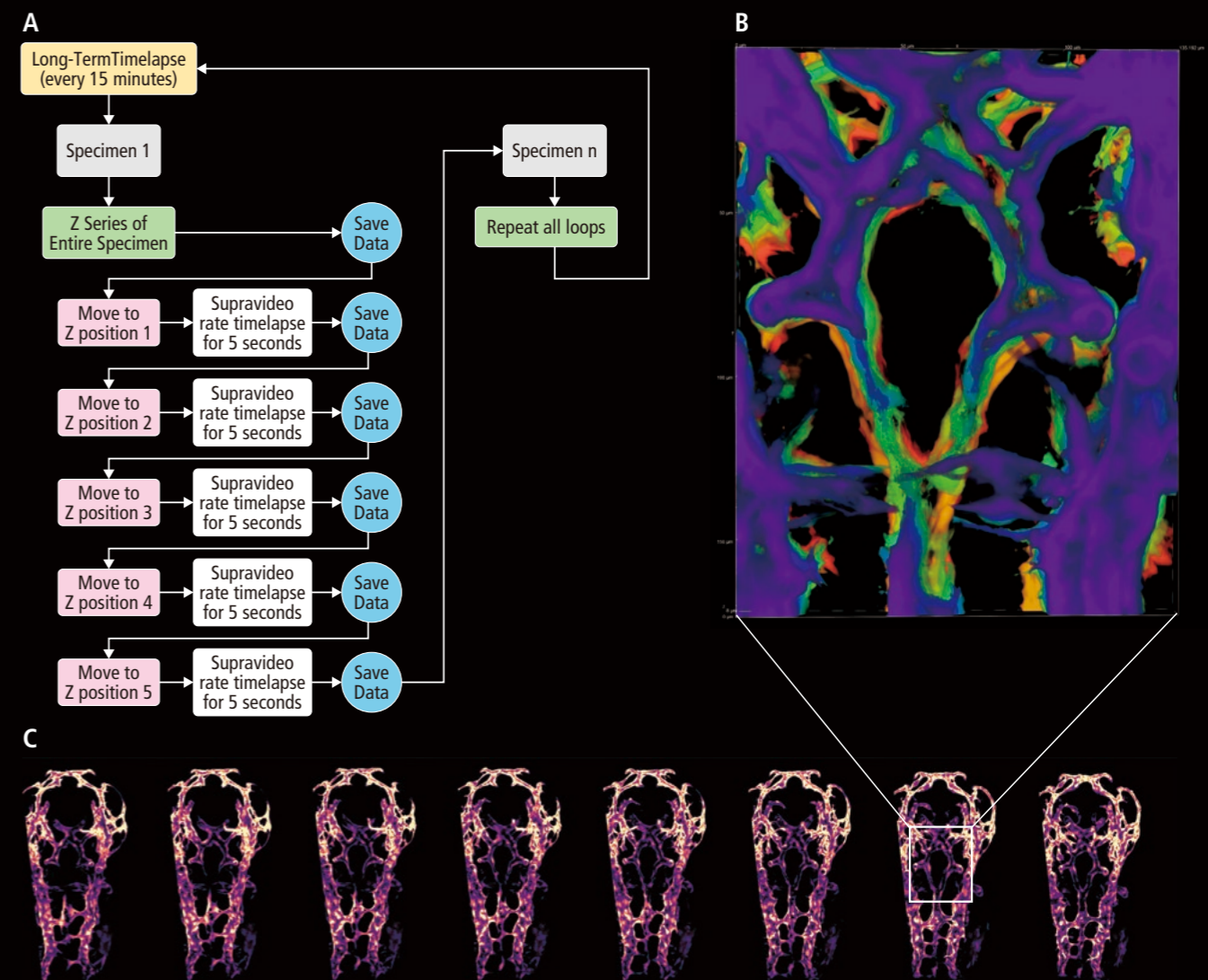

Time lapse images of *Danio* sp. vascular development acquired with a 25X SIL immersion objective using 1024 x 2048 AX R resonant scanning.

(A) JOBS experiment protocol shown above.

(B) Inset showing vascular development with overlay color representing time, where each color represents a different time point.

(C) Maximum intensity projections of entire FOV of Z series at points in time during the progress of the experiment.

Courtesy of Erika Dreikorn and Dr. Beth Roman, Department of Human Genetics, University of Pittsburgh Graduate School of Public Health.



AI Software Innovations Designed to Assist

From acquisition to analysis, Nikon's NIS-Elements software is a pioneering leader in the implementation of convolutional neural network (CNN) based deep learning for microscopy. Several AI tools are available, many targeted specifically for assisting users in acquiring, processing, and analyzing confocal data. These tools aid users in achieving adequate signal-to-noise ratio (SNR) images for image processing and analysis, and more tools for both segmentation and image enhancement or modality transformation.

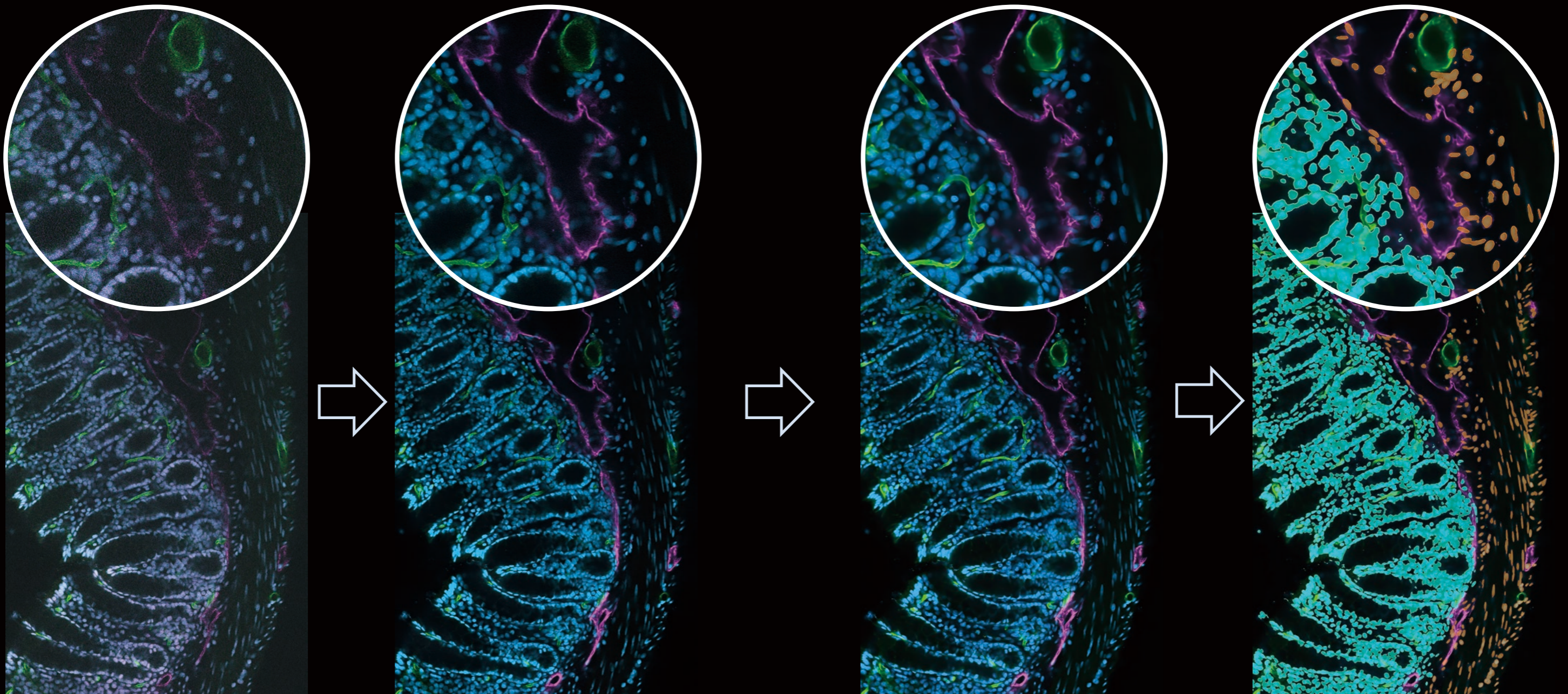

Starting Point

Confocal imaging has multiple variables that must be fine-tuned for the best image quality, a statistically valid signal-to-noise ratio, and long-term sample stability. NIS-Elements AI tools are designed to assist in achieving these targets.

Autosignal.ai

New for AX/AX R: Autosignal.ai can suggest the best illumination and detection settings automatically, instead of users manually attempting to find the best settings by trial and error, or while scanning live and exposing the sample unnecessarily.

Denoise.ai

Shot noise is the main noise source in confocal imaging. Denoise.ai can remove the shot noise component from confocal images, improving the image quality and assisting in downstream segmentation.

Segment.ai

A toolbox of AI functions assist users in easy segmentation of images; after training the AI, segmentation that would take hours by traditional methods (such as samples with uniform intensity, making traditional thresholding of different morphologies nearly impossible) can be done in seconds.

NIR Imaging Option

Incorporating the NIR Imaging Option enables near-infrared excitation in addition to conventional visible-light excitation. It allows the acquisition of more channels in multicolor fluorescence imaging, contributing to the understanding of complex structures in living specimens.

Bright, high-definition deep imaging

Near-infrared light has a high penetration depth into tissue and is less affected by light absorption and scattering. Acquiring near-infrared light with a high S/N ratio therefore enables high-definition observation of deep structures within living specimens. In addition, near-infrared light produces less autofluorescence, thus enabling clear imaging, and its low phototoxicity makes it effective for imaging living cells.

High wavelength selection flexibility

NIR imaging extended to the 730 nm and 785 nm lines allows excitation of fluorophores over a wide wavelength range from violet to near-infrared, which is effective for crosstalk-reduced imaging. Excitation in the NIR allows acquisition of additional dyes and thereby more structural details of specimens in multichannel imaging.

Highly sensitive NIR detection

Conventional GaAsP detectors can be replaced by detectors with high quantum efficiency (QE) in the NIR region, namely an Ex Red GaAsP Unit for 730 nm or a PMT-GAS GaAs Unit for 785 nm, enabling highly efficient NIR dye detection.

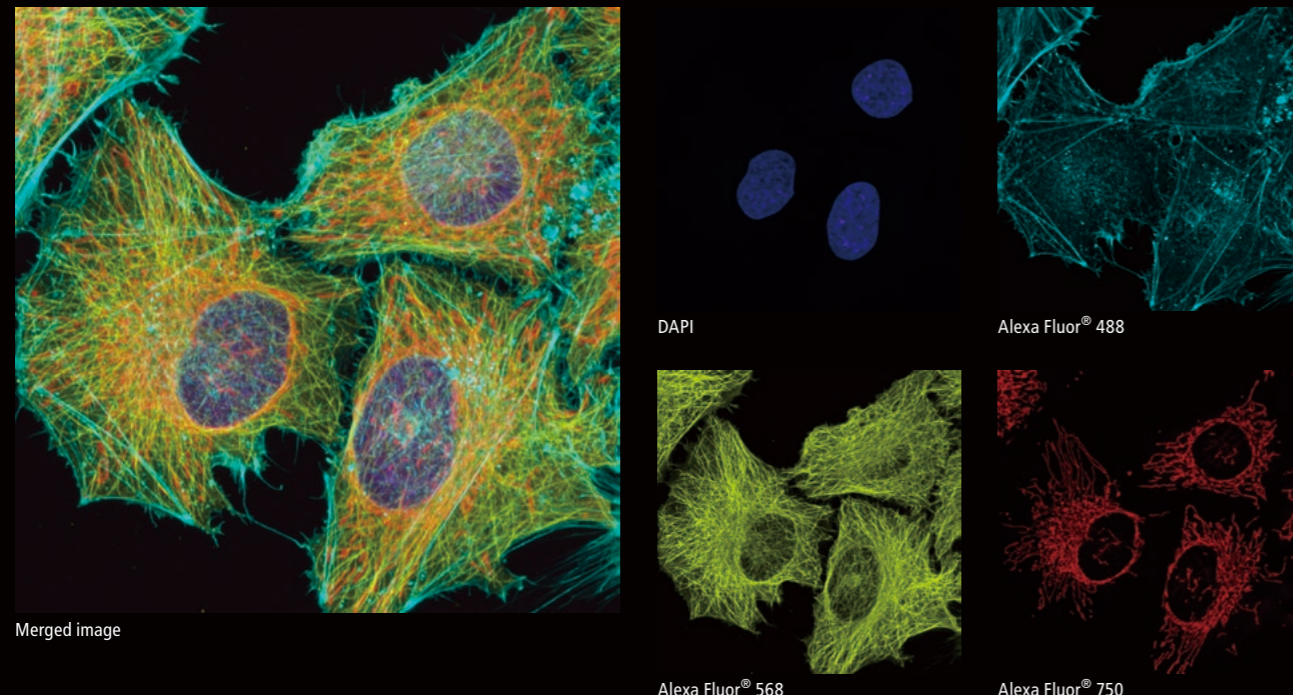

Merged image

Multi-stained specimen of HeLa cells acquired with visible and NIR light using the NIR imaging option.

Nucleus (DAPI), Actin (Alexa Fluor® 488), Tubulin (Alexa Fluor® 568), Mitochondria (Alexa Fluor® 750)

Optional Components

Water Immersion Dispenser

A software-controlled, automatic water dispenser enables long-term time-lapse imaging using refractive-index matching water immersion objectives in any environment, including incubation.



Automatic Correction Collar

Moves the objective correction collar to the optimum position for best resolution both remotely and by software control. Motorized collars allow users to adjust the correction collar without disturbing the specimen position, even in incubated enclosures or environmental chambers.



LAPP Modular illumination system

The Ti2-E microscope supports up to 5 episcopic illumination sources, which can be used in tandem with AX/AX R confocal imaging: total internal reflection fluorescence (TIRF), point, raster or field stimulation devices, and fluorescence light sources can all be integrated onto the same microscope stand, and used in the same experiments.



Total Internal Reflection Fluorescence (TIRF)

The incident angle of a laser and corresponding penetration depth of the evanescent field can be controlled via NIS-Elements software. When multiple TIRF modules are mounted, the penetration depth can be independently set for each wavelength.

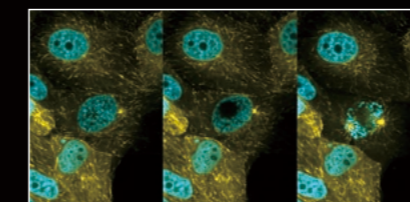
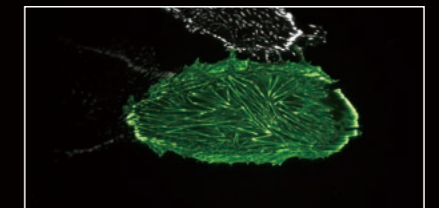

Photostimulation: Point and Raster Scanner

The XY galvano scanning unit can stimulate the desired area of a sample using laser point scanning. It allows simultaneous photostimulation and confocal imaging.

Photostimulation: Digital Micromirror Device (DMD)

The DMD module enables photoactivation of user-specified patterns rather than photoactivation of a single spot. This allows stimulation of multiple points and tracking of their behavior. The DMD module can be used with either laser illumination or less phototoxic LED illumination.

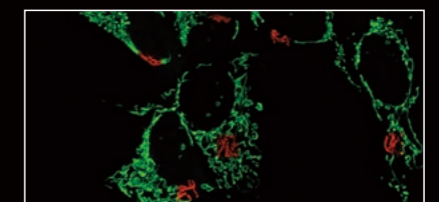

Opti-Microscan photostimulation device

This device enables photostimulation over a 400 to 700 nm wavelength range*, allowing photostimulation IR imaging with visible light. Simultaneous stimulation, sequential stimulation and manual stimulation are available.

* Depends on filter cube type.

System diagram

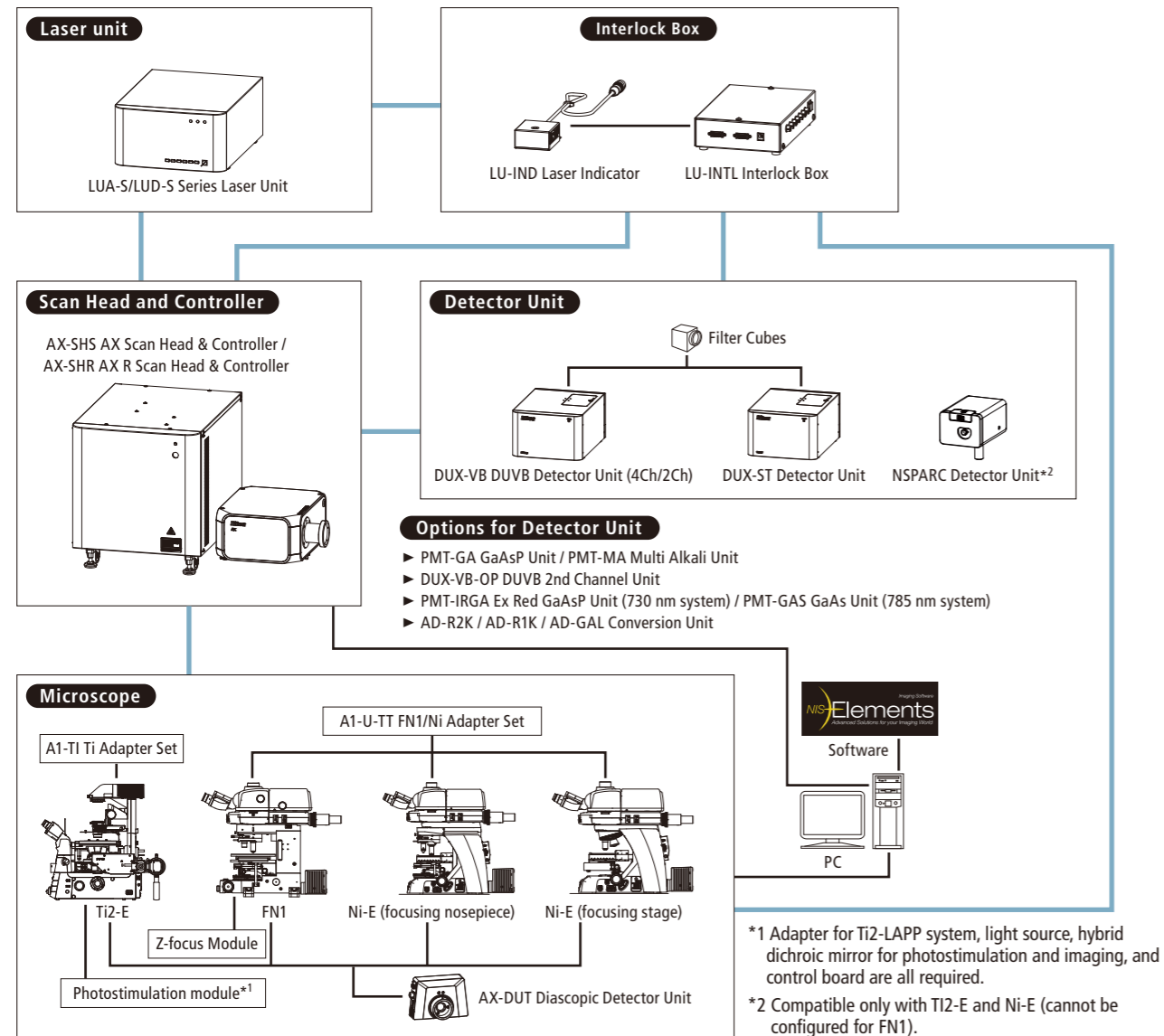

Layout

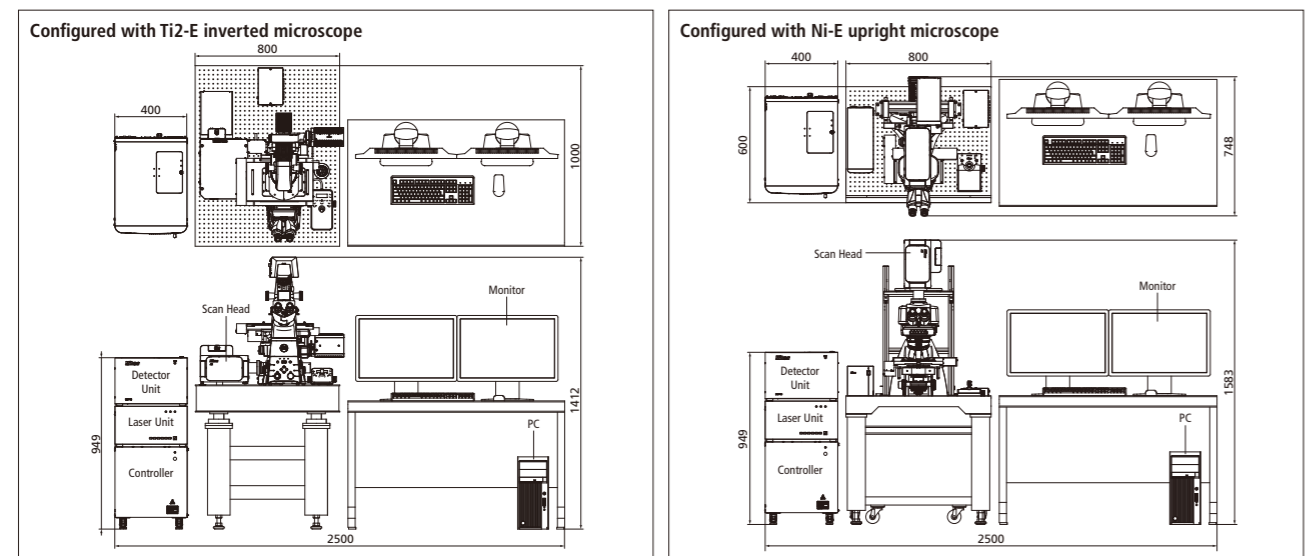

* Layout sample

Specifications

Scan Head	AX Galvano Scanner	25 mm FOV galvano scanner Up to 8192 x 8192 pixels Up to 10 fps at 512 x 512 pixels Pixel dwell time up to 2 milliseconds Supports bidirectional imaging and linescan imaging
	AX R Galvano+Resonant Scanner 2K or 1K	25 mm FOV resonant scanner 25 mm FOV galvano scanner Up to 2048 x 2048 pixels for 2K (1024 x 1024 pixels for 1K) Up to 720 fps at 2048 x 16 pixels for 2K (720 fps at 1024 x 16 pixels for 1K) 30 fps at 2048 x 512 pixels for 2K (1024 x 512 pixels for 1K) Supports bidirectional imaging and linescan imaging
Scan Head Input/Output Port		Standard: One laser input port and one laser output port; FC connection Option: One input port for visible or near-IR laser, and one laser output port can be added; FC connection
Dichroic Mirror		Up to 6 customizable mirrors
Pinhole		Variable aperture with 6 blades
FOV		Maximum 25 mm diameter (circle) inscribed by a rectangle
Laser		Up to 8 visible/near-IR lasers Compatible laser: (Standard) 405 nm to 750 nm, (option) 730 nm or 785 nm for NIR Imaging Option
Detector	DUX-VB Detector Unit	2 or 4 channels (4 channels when NIR Imaging Option is added) Freely tunable emission bands with ± 1 nm accuracy and up to 66 discrete spectral channels Up to 12 bandpass filters Multi-alkali PMT or GaAsP PMT is selectable (for NIR Imaging Option, select the Ex Red GaAsP PMT for 730 nm excitation or GaAs PMT for 785 nm excitation)
	DUX-ST Detector Unit	2 or 4 channels Up to 18 bandpass filters Multi-alkali PMT or GaAsP PMT options
	NSPARC Detector Unit	Lateral resolution 100 nm* ¹ , Axial resolution 300 nm* ¹ Equipped with SPCC (Single Pixel Photon Counter) array detector Up to 7 barrier filters can be mounted (supports excitation at 405 nm, 445 nm, 488 nm, 514 nm, 561 nm, 594 nm and 640 nm) With galvano scanner: Can be used with X resolution of 64 to 8192 pixels, Y resolution of 2 to 8192 pixels With resonant scanner: Can be used with X resolution of 256, 512, 1024 and 2048 pixels, Y resolution of 128 to 2048 pixels
Diascopic Detector		Compact PMT detector
Z step		Ti2-E: 0.01 μ m, 0.02 μ m (with encoder control), FN1 stepping motor: 0.05 μ m, Ni-E: 0.025 μ m
Compatible Microscopes		Ti2-E inverted microscope with maximum FOV of 25 mm Ni-E and FN1 upright microscopes with maximum FOV of 25 mm
Option		Photostimulation (point raster or digital micromirror) Fluorescence lifetime imaging including fast FLIM Piezoelectric Z (or XYZ) Environmental chamber or enclosure Other modalities such as TIRF, N-STORM or N-SIM S
Software		NIS-Elements C or NIS-Elements C-ER imaging software
Control Workstation		Microsoft Windows [®] 10 64bit/11 Professional with GPU-accelerated graphics card
Recommended Installation Conditions		Temperature 23 \pm 5 $^{\circ}$ C, Humidity 70% RH or less (no condensation)

*1 These values were measured using 40 nm diameter beads for lateral resolution and 100 nm diameter beads for axial resolution with excitation by a 488 nm laser. Actual resolution depends on laser wavelength and optical configuration.

AX series

Organelle structure in cultured cells



Cultured cells



Cell sheet/Preparation



Microchannel chip

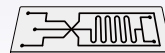

Sample animal



AX / AX R

AX NIR

AX R MP

AX / AX R with NSPARC

AX R MP with NSPARC

Specifications and equipment are subject to change without any notice or obligation on the part of the manufacturer. July 2024 ©2024 NIKON CORPORATION



WARNING

TO ENSURE CORRECT USAGE, READ THE CORRESPONDING MANUALS CAREFULLY BEFORE USING YOUR EQUIPMENT.

Monitor images are simulated.

Company names and product names appearing in this brochure are their registered trademarks or trademarks.

N.B. Export of the products* in this brochure is controlled under the Japanese Foreign Exchange and Foreign Trade Law. Appropriate export procedure shall be required in case of export from Japan.

*Products: Hardware and its technical information (including software)

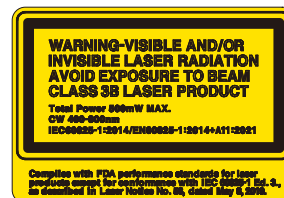

NIKON CORPORATION

Head office

1-5-20, Nishioi, Shinagawa-ku, Tokyo 140-8601, Japan
<https://www.healthcare.nikon.com/en/>

Manufacturer

471, Nagaodai-cho, Sakae-ku, Yokohama, Kanagawa 244-8533, Japan

Nikon Instruments Inc.

1300 Walt Whitman Road, Melville, N.Y. 11747-3064, U.S.A.
 phone: +1-631-547-8500; +1-800-52-NIKON (within the U.S.A. only)
 fax: +1-631-547-0299
<https://www.microscope.healthcare.nikon.com/>

Nikon Europe B.V.

Stroombaan 14, 1181 VX Amstelveen, The Netherlands
 phone: +31-20-7099-000
https://www.microscope.healthcare.nikon.com/en_EU/

Nikon Precision (Shanghai) Co., Ltd.

CHINA phone: +86-21-6841-2050 fax: +86-21-6841-2060
 (Beijing branch) phone: +86-10-5831-2028 fax: +86-10-5831-2026
 (Guangzhou branch) phone: +86-20-3882-0550 fax: +86-20-3882-0580
<https://www.nikon-precision.com.cn/>

Nikon Canada Inc.

CANADA phone: +1-905-625-9910 fax: +1-905-602-9953

Nikon France, Succursale de Nikon Europe B.V.

FRANCE phone: +33-1-4516-4516

Nikon Deutschland, Zweigniederlassung der Nikon Europe B.V.

GERMANY phone: +49-211-9414-888

Nikon Italy, Branch of Nikon Europe B.V.

ITALY phone: +39-055-300-9601

Nikon Europe B.V., Amstelveen, Zweigniederlassung Schweiz (Egg/ZH)

SWITZERLAND phone: +41-43-277-2867

Nikon UK, Branch of Nikon Europe B.V.

UNITED KINGDOM phone: +44-208-247-1717

Nikon Österreich, Zweigniederlassung der Nikon Europe B.V.

AUSTRIA phone: +43-1-972-6111

Nikon Singapore Pte. Ltd.

SINGAPORE phone: +65-6559-3651 fax: +65-6559-3668

Nikon Australia Pty Ltd

AUSTRALIA phone: +61-2-8767-6900

Nikon Instruments Korea Co., Ltd.

KOREA phone: +82-2-6288-1900 fax: +82-2-555-4415

NIKON INDIA PVT. LTD.

INDIA phone: +91-124-4688-500